

Cisco Catalyst 8500 Series Edge Platform Deep Dive

Highly Capable WAN Aggregation Platforms

Sumant Mali - Engineering Product Manager
@sumantmali
BRKARC-2885

“Want to be ‘the Catalyst 8500 Expert’?”

I promise to reveal all the secrets
for you today! 😊

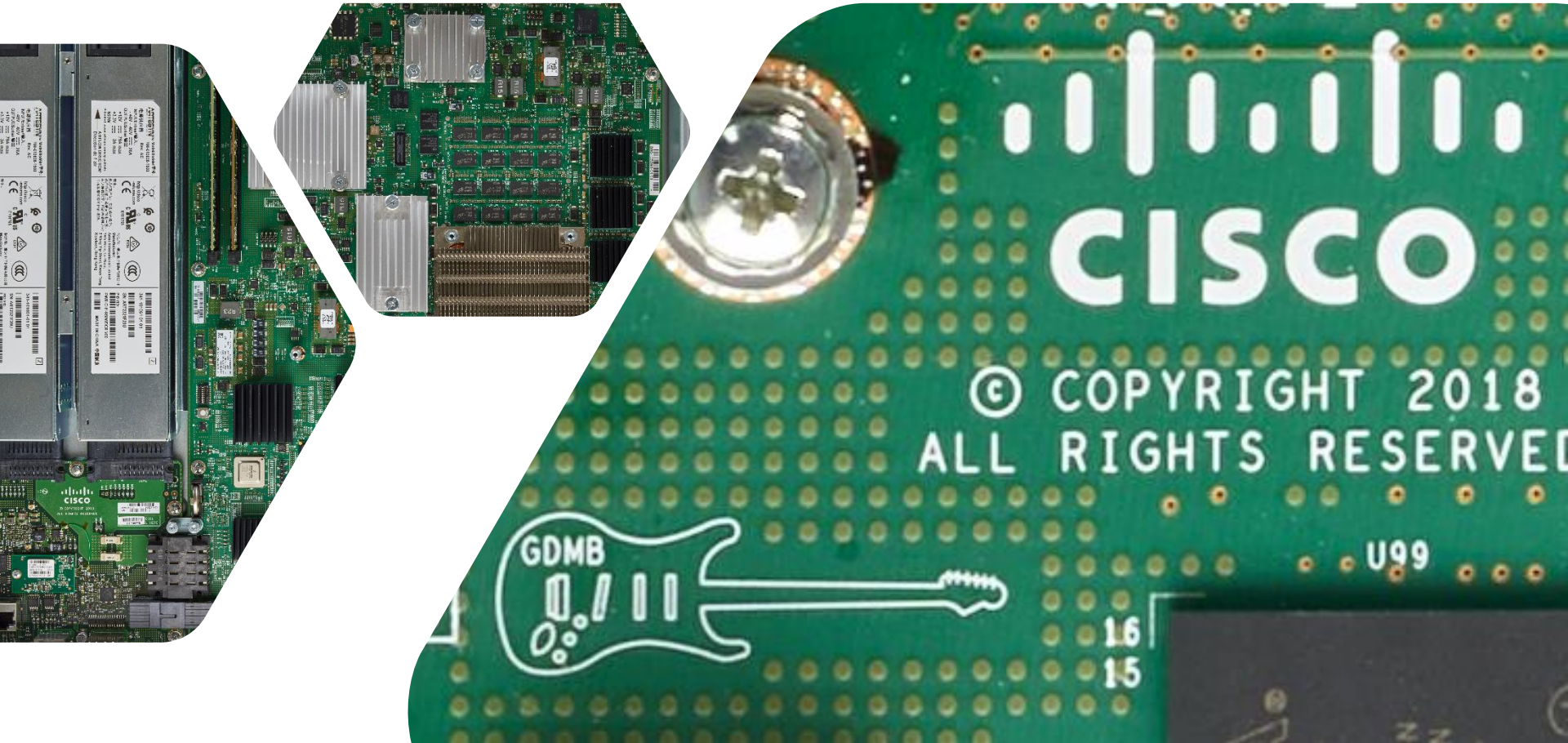

Webex App

Questions?

Use the Webex app to chat with the speaker after the session

How

- 1 Find this session in the Cisco Events mobile app
- 2 Click “Join the Discussion”
- 3 Install the Webex app or go directly to the Webex space
- 4 Enter messages/questions in the Webex space

Webex spaces will be moderated by the speaker until February 28, 2025.

CISCO *Live!*

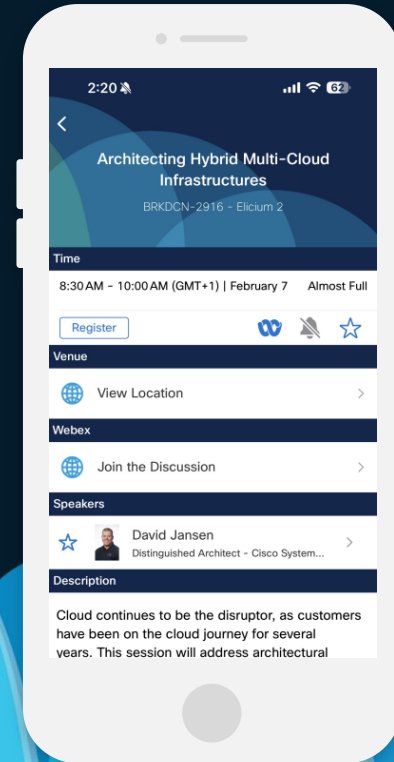

Agenda

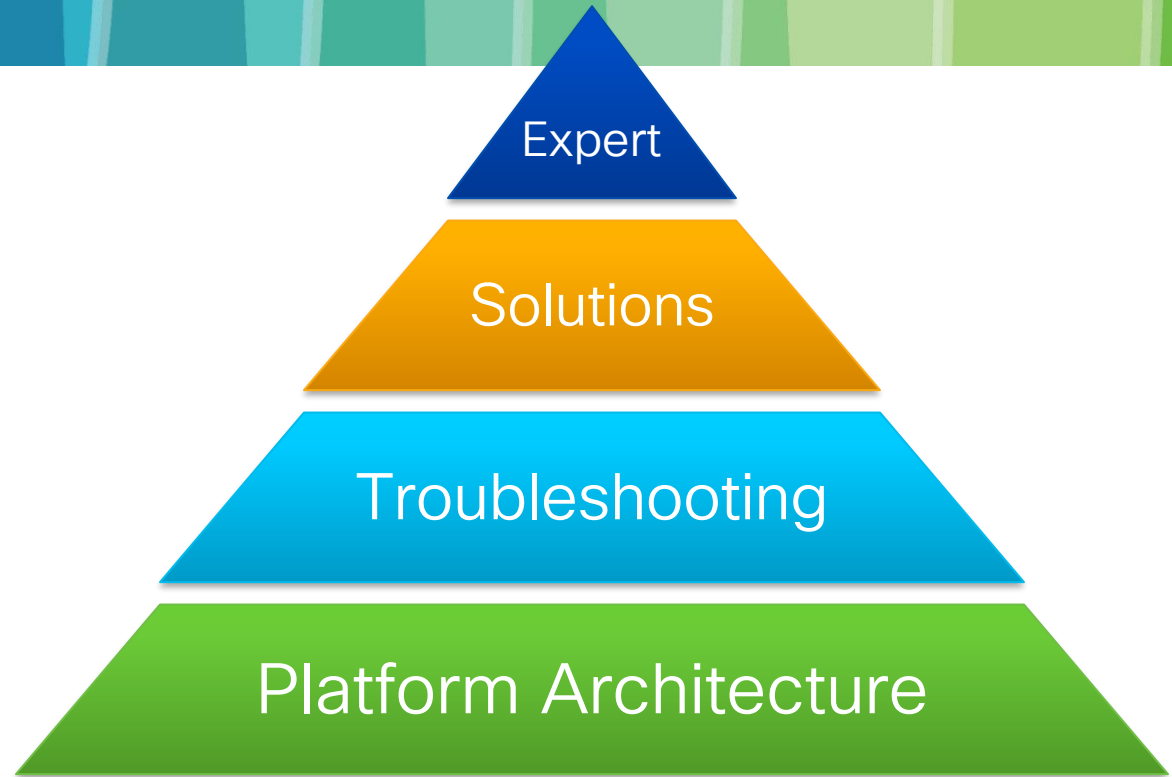

Catalyst 8500 Series Edge Platforms

CISCO *Live!*



Catalyst 8500-20X6C Series Edge Platform

100/40G
'C'

10/1G
'X'

C8500-20X6C



6 QSFP28

20 SFP+

Up to 500 Gbps CEF,
High Performance IPsec

4x 3rd Generation QFP,
Hardware Accelerated Services

User Centric Design,
RFID, FRUs



Catalyst 8500, 8500L Series Edge Platforms

100G, 40G
'C' 'Q'



C8500-12X4QC

12 SFP+,
4 QSFP

10G, 1G
'X'

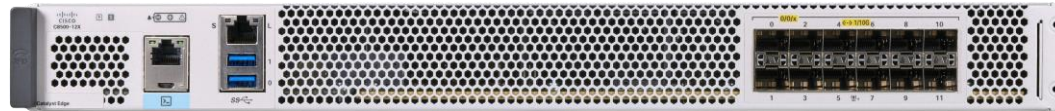

C8500-12X

12 SFP+

10G, 1G
'X' 'S'



C8500L-8S4X

8 SFP,
4 SFP+

Catalyst 8500 Platform Architecture

CISCO *Live!*



Third Generation QFP Architecture



Multi-threaded Parallel Processing

- 28 clusters of 8 PPEs each
- 224 PPEs, 4 threads each → 896 threads

Hardware Accelerated Crypto

- 16 Crypto Engines with dedicated resources
- Flow queues for complex stateful features

Layer-2 Aggregation

- 240Gbps of aggregation
- Per Port Classification and Accounting



QFP 3.0

Third Generation QFP Architecture



Multi-threaded Parallel Processing

- 28 clusters of 8 PPEs each
- 224 PPEs, 4 threads each → 896 threads

Hardware Accelerated Crypto

- 16 Crypto Engines with dedicated resources
- Flow queues for complex stateful features

Layer-2 Aggregation

- 240Gbps of aggregation
- Per Port Classification and Accounting

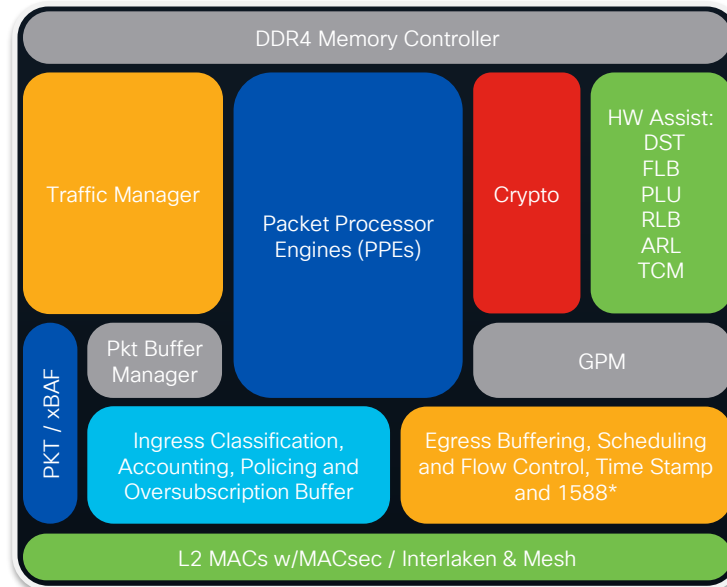

QFP 3.0

QFP 3.0 Traffic Manager



Improved Queuing Capabilities

- 256K queues
- 5-layer MQC-compatible QoS
- 134K scheduling nodes
- Single queue maximum rate of 60 Mpps for single chip
 - 75 Mpps for multi-QFP complex

Flow Control, GEC

- Event Driven (Xon/Xoff) flow control support on all egress queues
- Ether-channel support for bundled ports supported for single and multi-QFP complexes

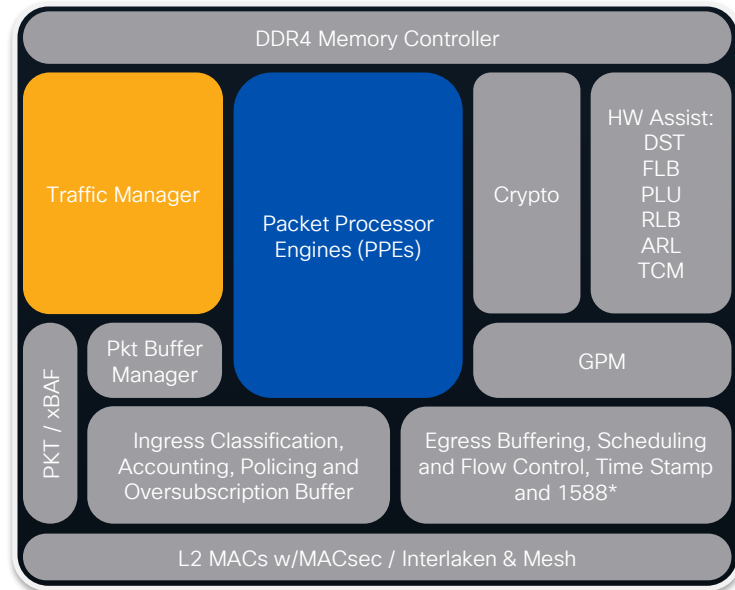

QFP 3.0 In-line Crypto



Integrated 16 Crypto Engines

Each Crypto Engine contains

- Packet input buffer, cipher, digest, and checksum engines
- Fully capable cipher engines for supported cipher algorithms
- Fully capable digest engines for underlying digest algorithms

| Digest Cipher | SHA1 | SHA2-256/384/512 | MD5 | GCM |
|---------------|------|------------------|-----|-----|
| AES | ✗ | ✓ | ✗ | ✓ |
| DES/3DES | ✗ | ✗ | ✗ | N/A |

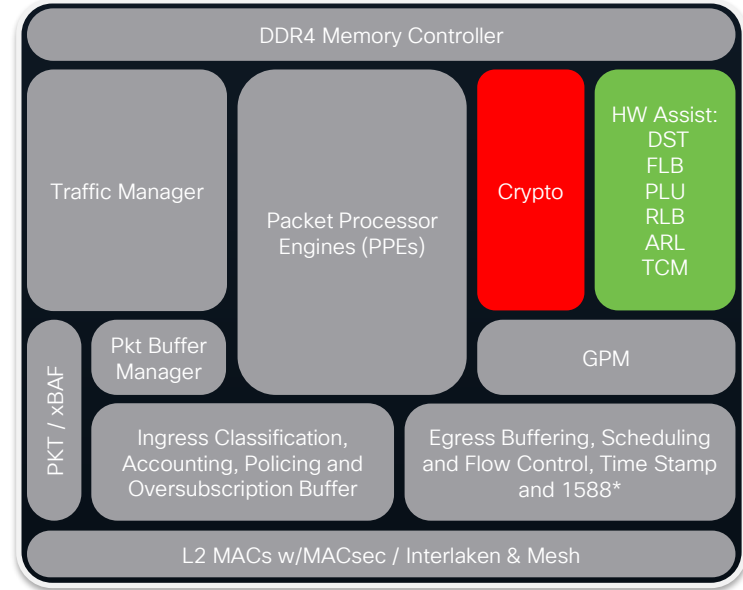

QFP 3.0 Layer 2 Sub-system



Layer 2 Aggregation

- 240Gpbs ethernet port aggregation
- Per port 12.5ms Ingress Oversubscription Buffers

Classification, Accounting

- Supports per port, L2/L3, TCAM based classification
- Supports Ingress sub-intf classification
- Supports Ingress and Egress per Port High, Low priority accounting

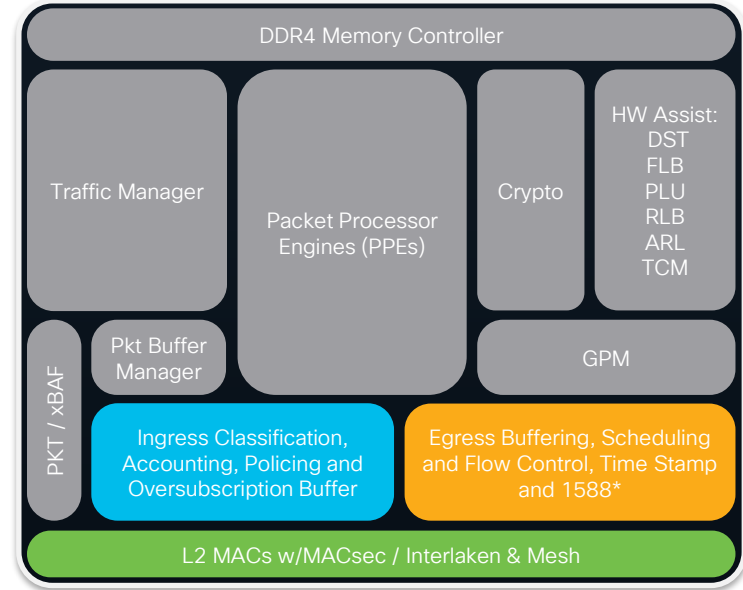

**In C8500, MACsec is implemented in PHY, not in QFP

*1588 is not supported feature at this moment

C8500-20X6C Block Diagram

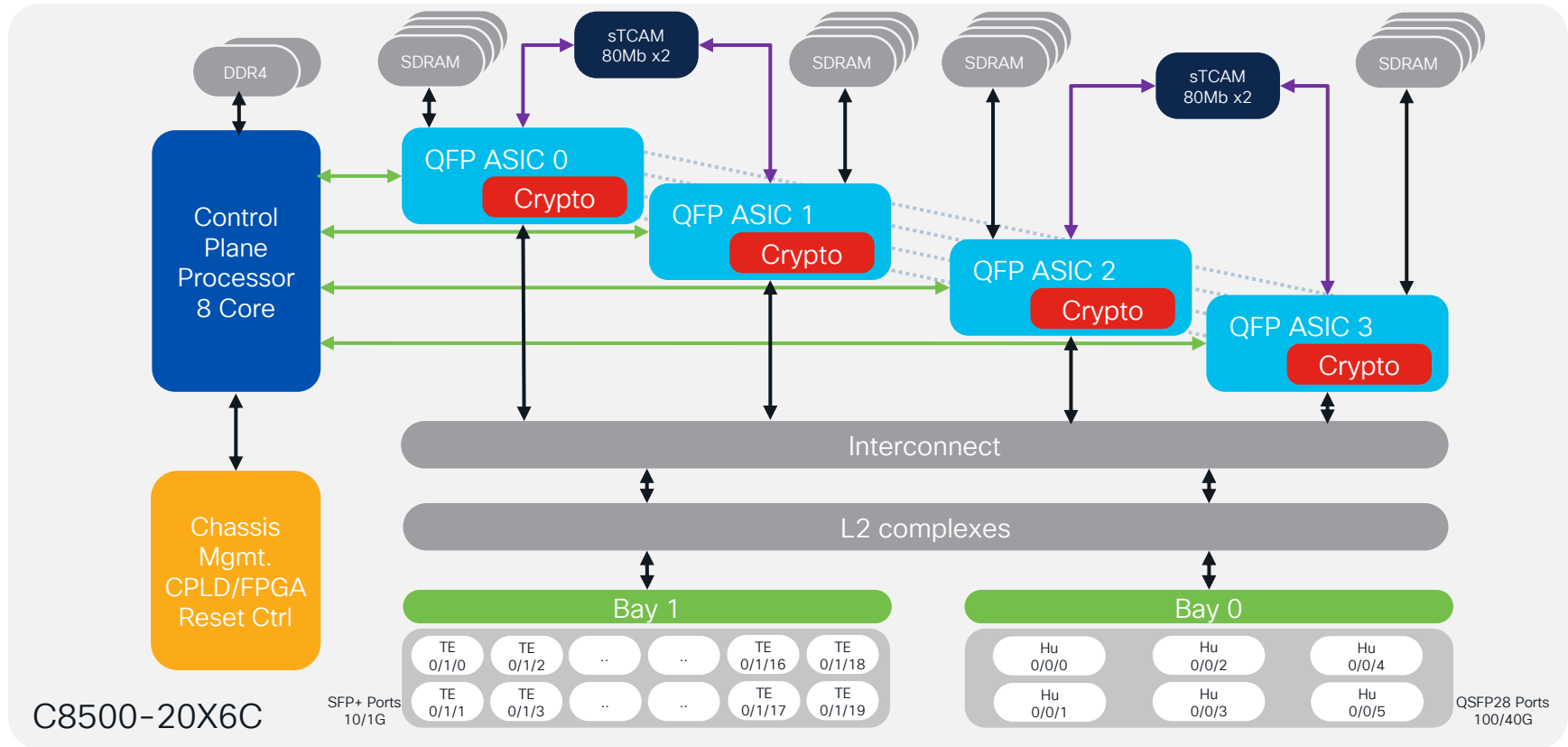

C8500-12X4QC Block Diagram

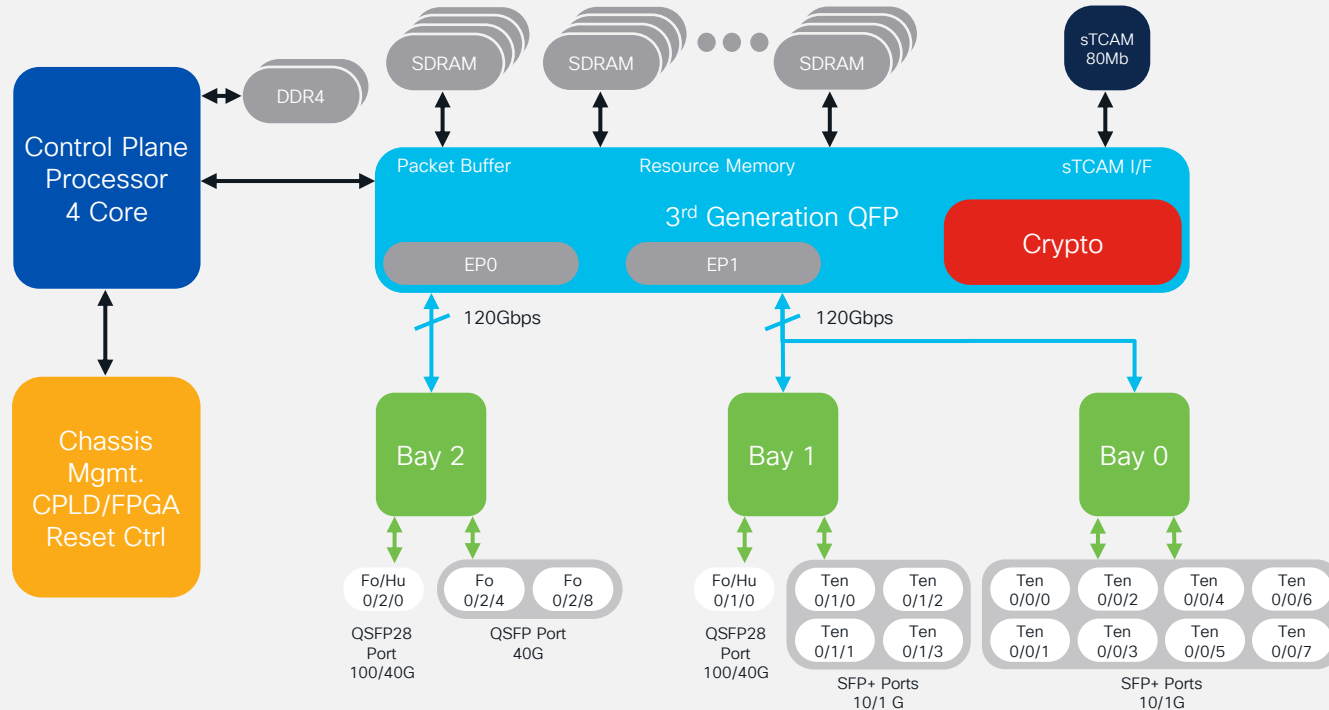

C8500-12X4QC

C8500-12X Block Diagram

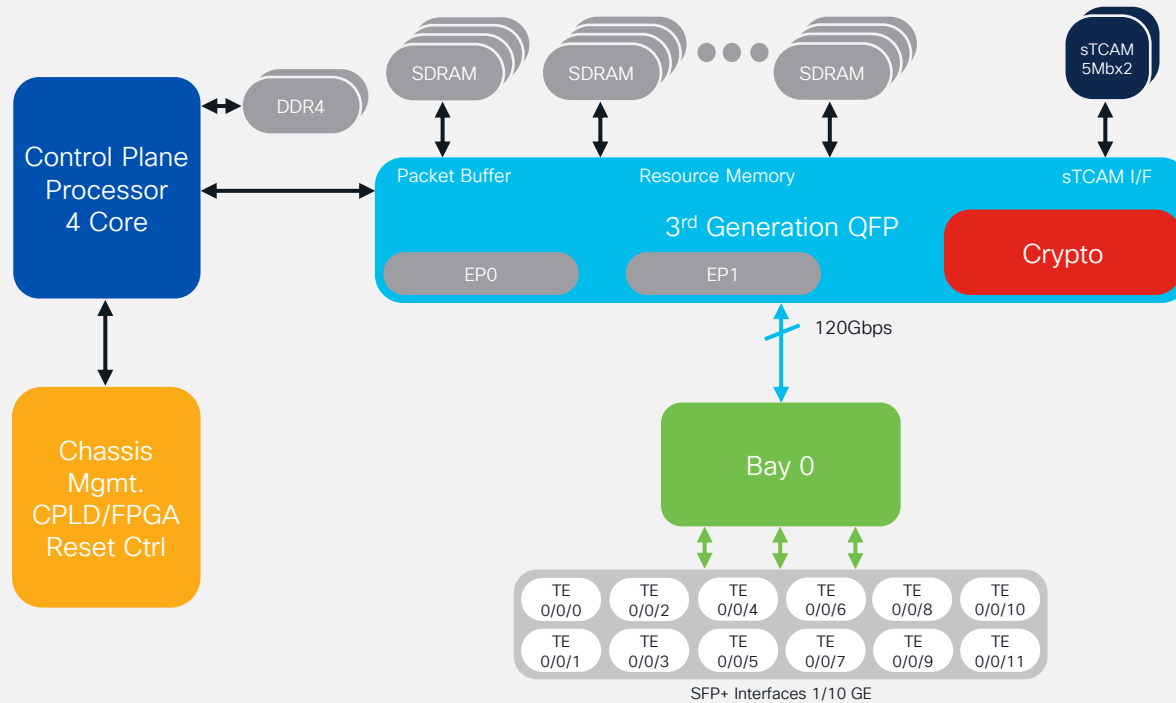

C8500-12X

Life of a Packet

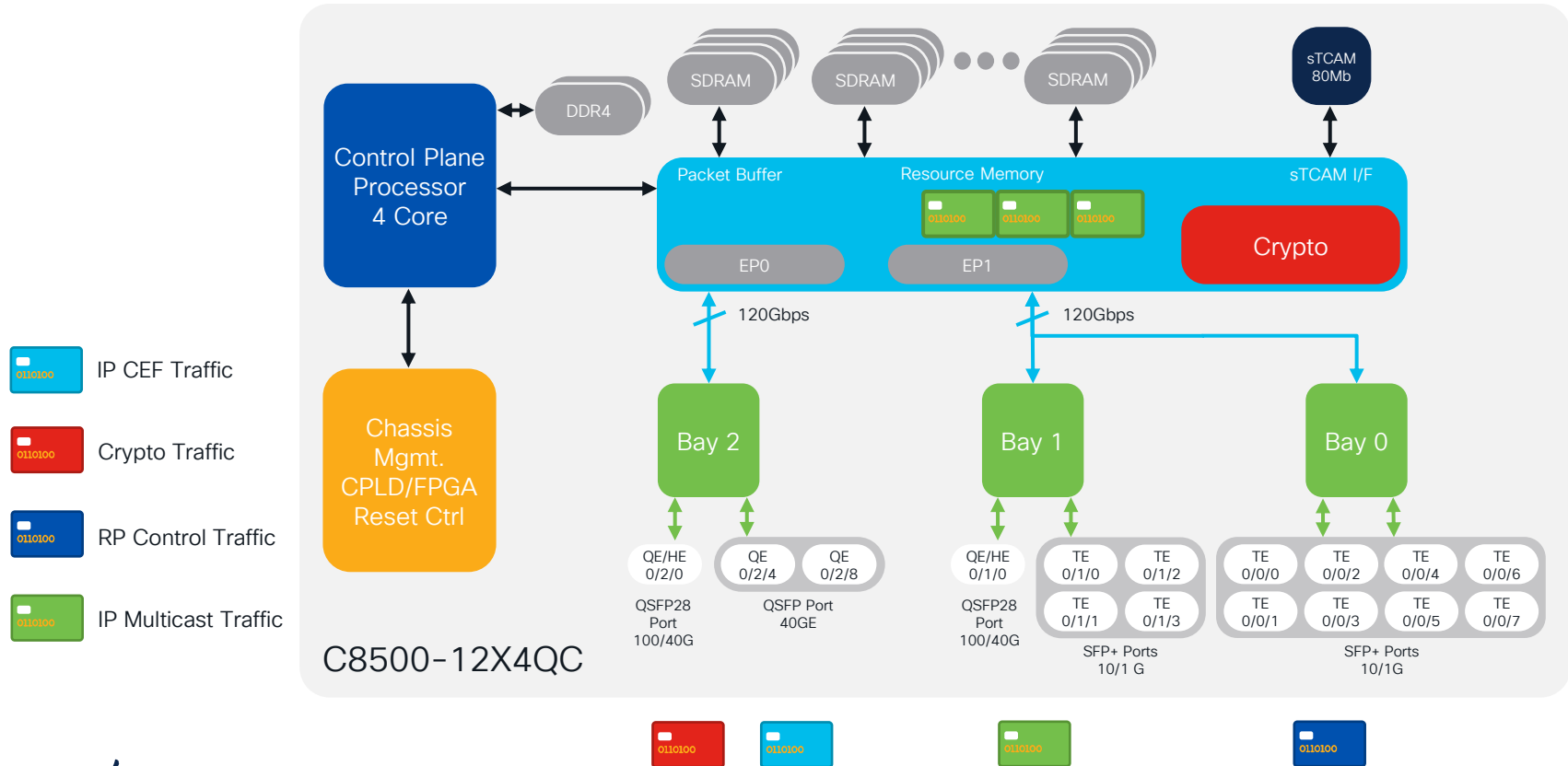

C8500-12X4QC Port Connectivity

Purpose-built 100GE, 40GE Port SD-WAN 1RU Platform

Max 120G of ports from Bay 2

Max 120G of ports across Bay 0 + Bay 1

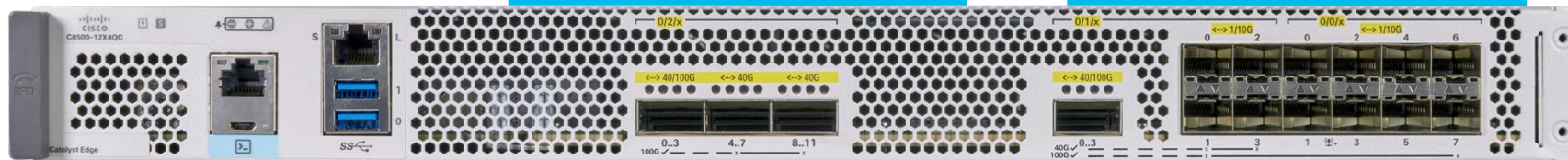

| Option | Port Speed | Maximum Port Configuration |
|--------|-------------|---|
| 1 | 100GE | 2x100G |
| 2 | 100/40GE | 1x100GE + 3x40GE |
| 3 | 100/40GE | 1x100GE + 12x10GE |
| 4 | 40/10GE | 4x40GE + 8x10GE |
| 5 | 40/10GE | 3x40GE + 12x10GE |
| 6 | 100/40/10GE | 1x100GE + 1x40GE + 8x10GE |
| 7 | 10GE | 12x10GE + 12x10GE (using breakout* cable) |
| 8 | 1GE | 12x1GE |

100GE, 40GE Connectivity Options (i)

C8500-12X4QC

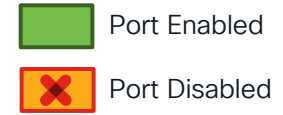

Option 1

2 x 100GE

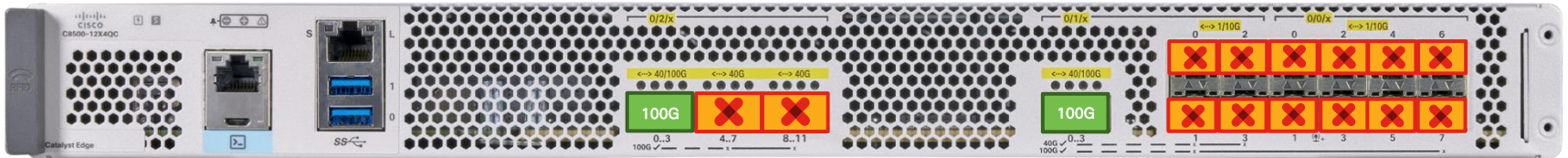

Option 2

1 x 100GE + 3 x 40GE Ports

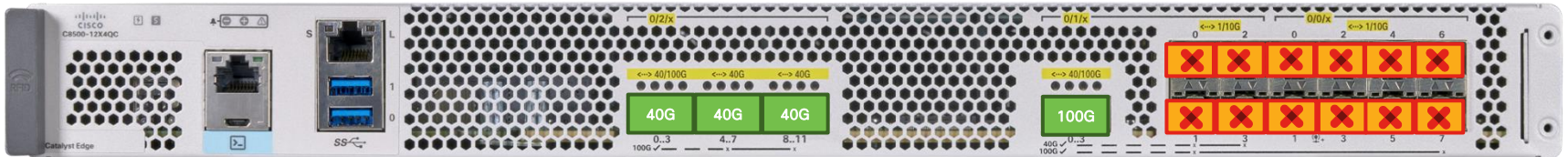

Note: For port speed change on any bay; there is an expected 1 sec traffic disruption due to backplane reset

100GE, 40GE Connectivity Options (ii)

C8500-12x4QC

 Port Enabled

 Port Disabled

Option 3

1 x 100GE + 12 x 10GE

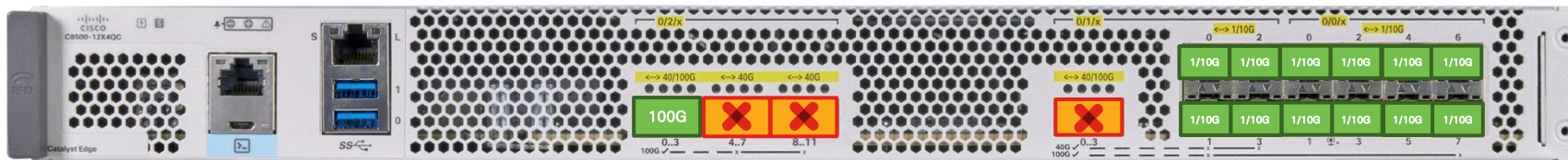

Option 4

4 x 40GE + 8 x 10GE



Note: For port speed change on any bay; there is an expected 1 sec traffic disruption due to backplane reset

100GE, 40GE Connectivity Options (iii)

C8500-12x4QC

 Port Enabled

 Port Disabled

Option 5

3 x 40GE + 12 x 10GE



Option 6

1 x 100GE + 1 x 40GE + 8 x 10GE

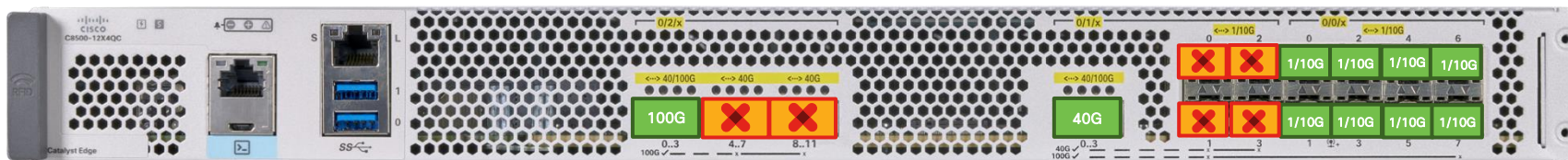

Note: For port speed change on any bay; there is an expected 1 sec traffic disruption due to backplane reset

C8500-12X4QC, Bay Speed Configuration

Autonomous Mode for Routing

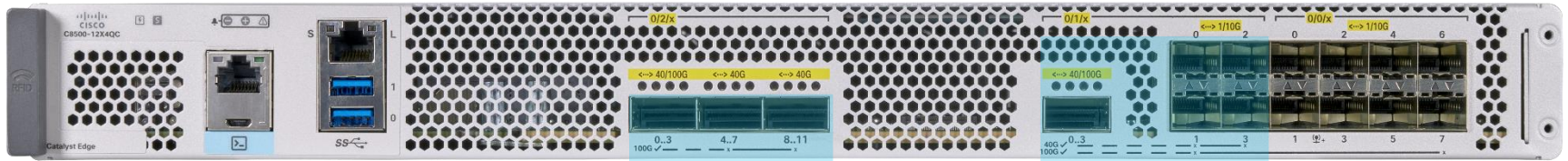

```
C8500(config)# hw-module subslot 0/1 mode ?
  100G  configure EPA to 100G mode
  10G   configure EPA to 10G mode
  40G   configure EPA to 40G mode

Router(config)#hw-module subslot 0/1 mode 100G
Present configuration of this subslot will be erased and will not be
restored.
CLI will not be available until mode change is complete and EPA
returns to OK state.
Do you want to proceed? [confirm]
<snip>
```

C8500-12X4QC, Bay Speed Configuration

Controller Mode for SD-WAN

The screenshot shows the Cisco vManage configuration interface. At the top, the breadcrumb navigation is "Feature Template > Add Template > Dynamic Interface Mode", which is highlighted with a yellow border. Below this, the "Device Type" is set to "Test514". There are input fields for "Template Name" and "Description". The "SUBSLOT MODE PARAMETERS" section contains three rows for "Bay 0", "Bay 1", and "Bay 2". Each row has a dropdown menu for selecting a speed configuration. The dropdown for Bay 1 is open, showing options: "8*10g", "-- Choose --", "4*10G", "1*40G" (which is selected with a blue checkmark), and "1*100G". At the bottom of the configuration area, there are "Save" and "Cancel" buttons.

Device Type: Test514

Template Name: [Input Field]

Description: [Input Field]

SUBSLOT MODE PARAMETERS

| Bay | Configuration |
|-------|---------------|
| Bay 0 | 8*10g |
| Bay 1 | 1*40G |
| Bay 2 | 1*100G |

Buttons: Save, Cancel

C8500-12X4QC, Bay Speed Configuration

Controller Mode for SD-WAN



| SUBSLOT MODE PARAMETERS | |
|-------------------------|--------|
| Bay 0 | 8*10g |
| Bay 1 | 1*40G |
| Bay 2 | 1*100G |

High Density 10GE, 1GE Connectivity Options

C8500-12X and C8500-12x4QC

 Port Enabled

 Port Disabled

Option 7, 8 C8500-12X: 12 x 1/10GE

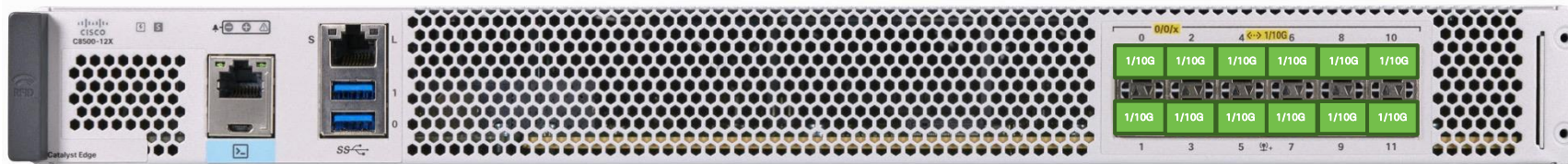

Option 7, 8 C8500-12X4QC: 12 x 1/10GE + 12 x 10GE*

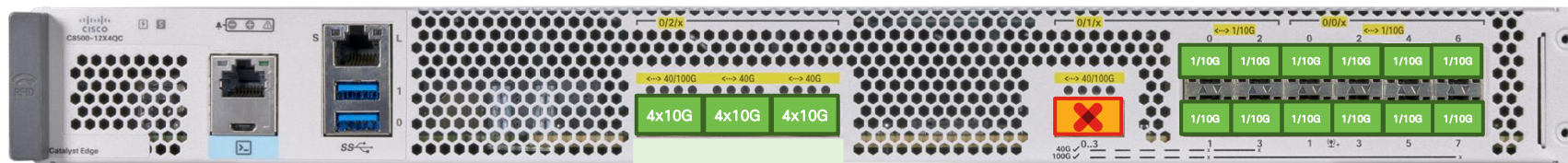

12 x 10GE using Breakout Cable

*C8500-12X4QC breakout cable is supported from 17.4.1 and on Autonomous mode only.

C8500-12X4QC Breakout Cable

40GE Speed Interfaces in bay-2 → breakout into 4 x 10GE ports each

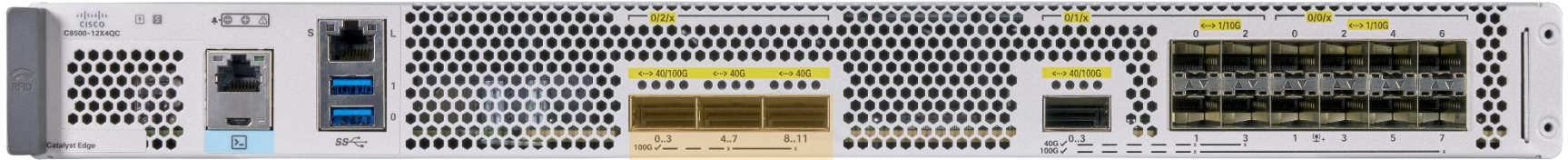

```
Router(config)#hw-module subslot 0/2 mode 40g
Router(config)#
Router(config)#hw-module subslot 0/2 breakout 10G port ?
all          configure all native ports in breakout mode
native_port_0  configure native port 0 in breakout mode
native_port_4  configure native port 4 in breakout mode
native_port_8  configure native port 8 in breakout mode
```

*Support on Autonomous mode for Routing from 17.14.1 onward only

Advanced Flow-based Forwarding

Re-imagined x86 Forwarding Architecture



Quick Assist Technology

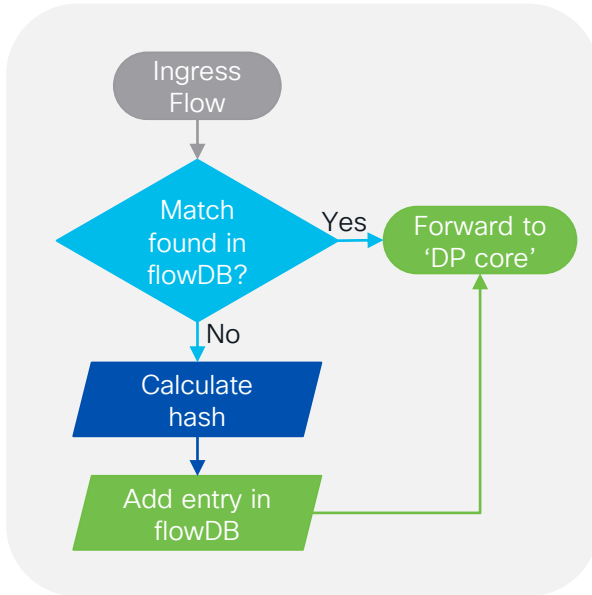

| Protocol | Tuple hashing elements |
|---------------------|---|
| TCP/UDP | srcIP, dstIP, protocol, srcPort, dstPort, vrfID |
| ESP | srcIP, dstIP, protocol, vrfID |
| All other Protocols | srcIP, dstIP, protocol, vrfID |

Data Plane vs Service Plane Heavy

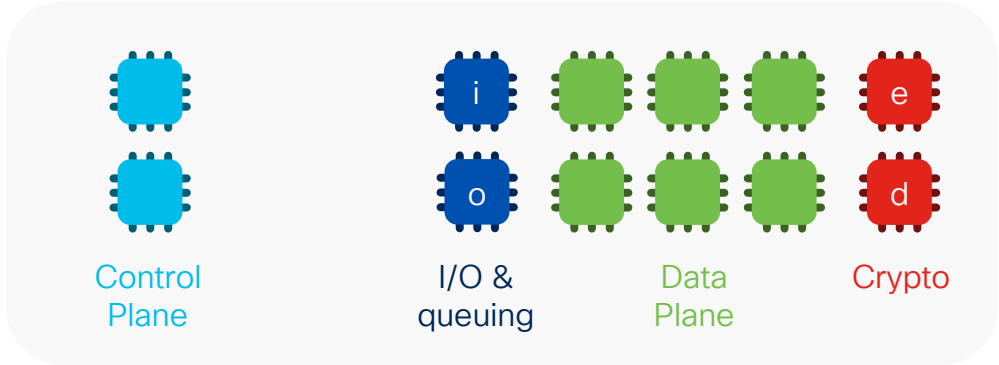

CLI configuration and reboot required to change modes. Roadmap for future software to not require reboot.

C8500L Data Plane Heavy

Configure, Verify



```
C8500L(config)#platform resource data-plane-heavy
C8500L(config)# do show platform software cpu allocation
CPU alloc information:
```

```
Control plane cpu alloc: 0-1,12-13
```

```
Data plane cpu alloc: 2-11
```

```
Service plane cpu alloc: 0
```

```
Template used: CLI-data_plane_heavy
```

```
C8500L(config)#
```

All cores allocated
for Data Plane

DP heavy is the default mode for IOS XE Routing 'autonomous' mode operation

C8500L Service Plane Heavy

Configure, Verify



```
C8500L(config)#platform resource service-plane-heavy
C8500L(config)# do show platform software cpu allocation
CPU alloc information:
```

```
Control plane cpu alloc: 0-1,12-13
```

```
Data plane cpu alloc: 6-11
```

```
Service plane cpu alloc: 2-5,14-17
```

```
Template used: CLI-service_plane_heavy
```

```
C8500L(config)#
```

4 x 2 hyperthreaded
cores for Service Plane

SP heavy is the default mode for Cisco SD-WAN 'controller' mode operation

C8500L-8S4X Block Diagram

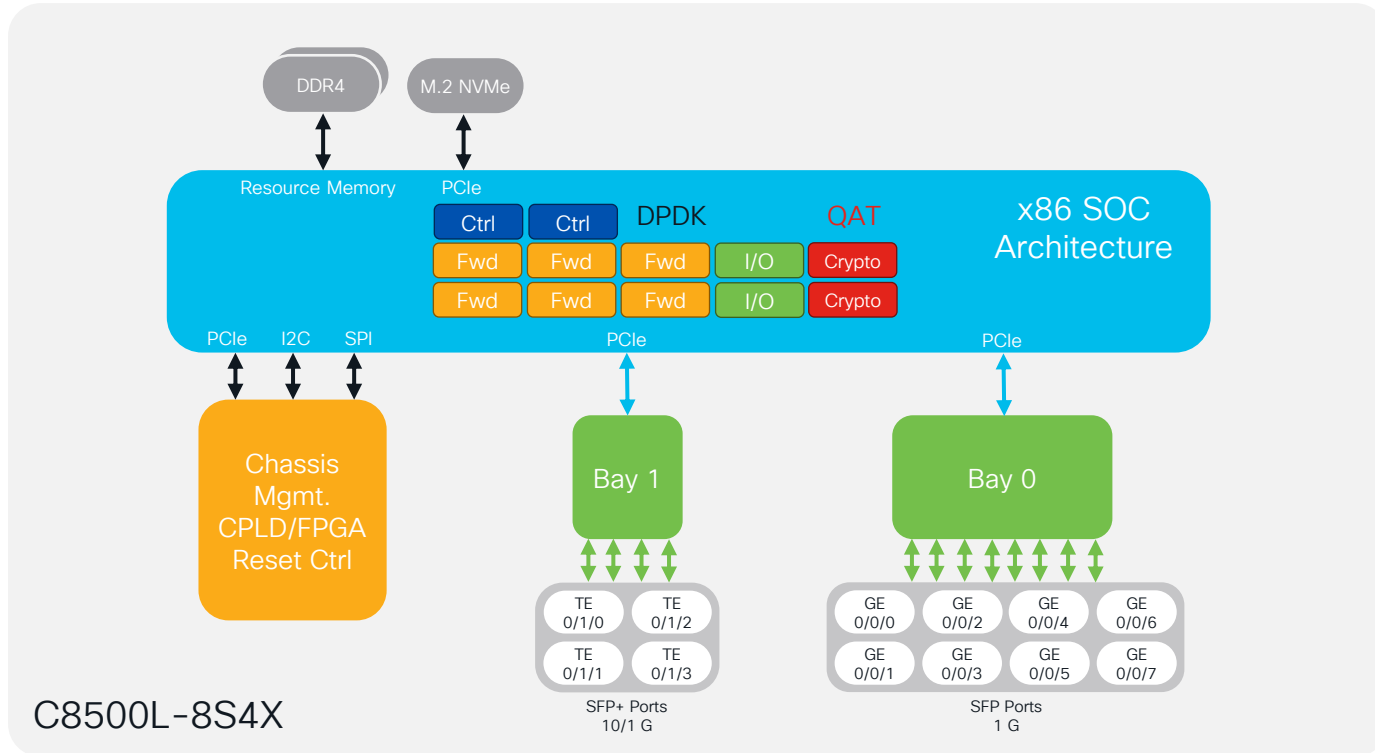

Secure Platform with Trustworthy Technologies

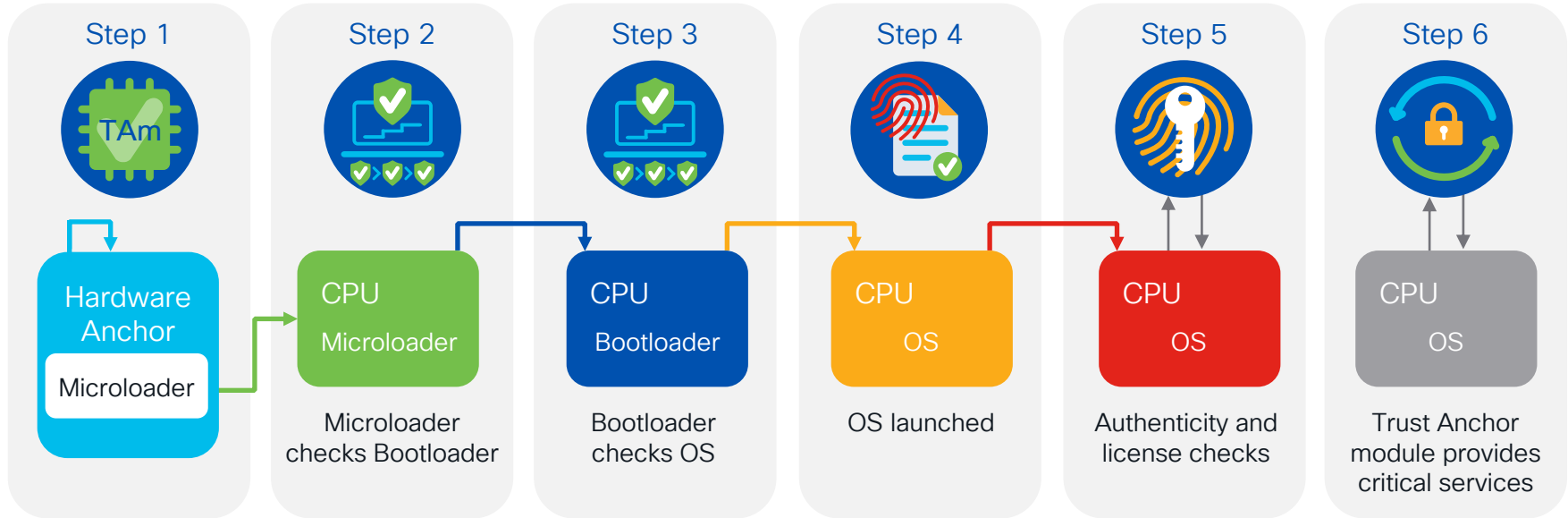

First instructions run on CPU stored in Tamper-resistant hardware

Confidentiality

Integrity

Authenticity

Catalyst 8500 User Centric Design

CISCO *Live!*



Radio Frequency Identification (RFID)



Front Facing *Passive UHF RFID*

Ultra High Frequency (*UHF*)

860 to 960 MHz
1-to-4-meter Distance

Benefits

Good read range
Industry adopted standard
Supply Chain Applications

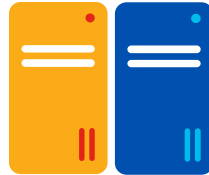

RFID Tag

Label Tray



Label Tray

Label Tray has a **plastic strip** that can be pulled out

Label Tray contains

- Product ID
- PID version ID
- CLEI
- TAN
- MAC and
- Hardware version number



Label tray contains a **QR code** with encoded information

AC, DC Power Supply

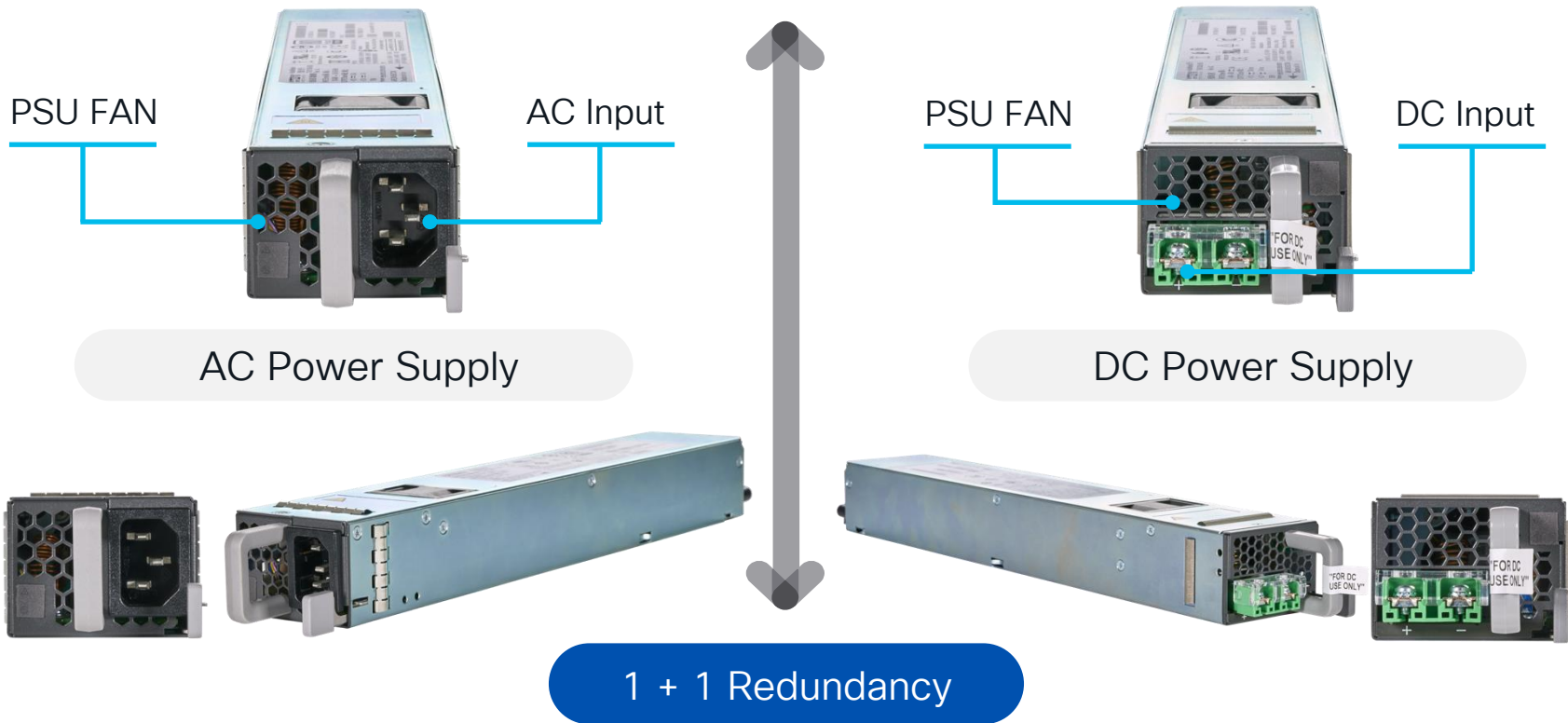

Field Replaceable FAN Module



Replaceable FAN Tray

$N + 1$ FAN Redundancy

Front-to-Back Airflow

Front Panel LED Indicators



Built-in Port LEDs

LED OFF ➔ Port is not enabled by software

LED Amber ➔ Port is enabled by software, but problem with link

LED Green ➔ Port is enabled by software and link is valid

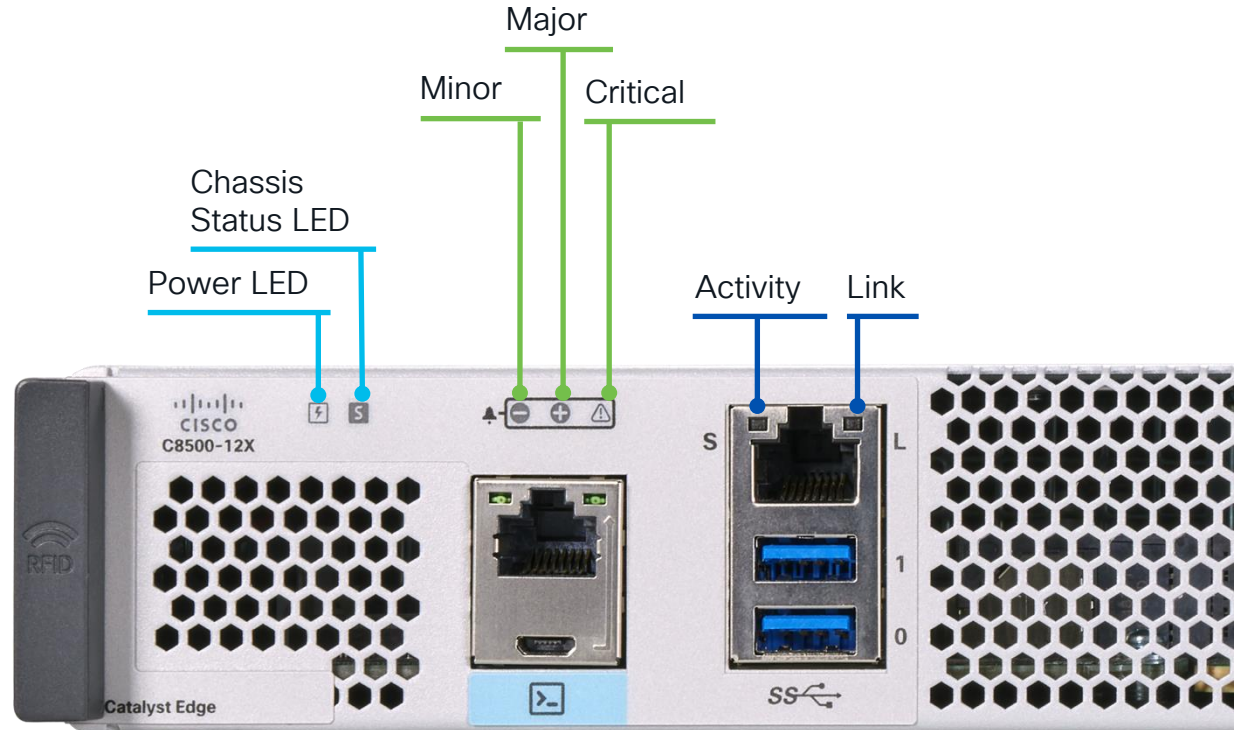

Management Flexibility



Console Flexibility

Traditional RJ45 Console Port
Micro USB Console Port

Out-of-band Management

Dedicated Management Interface

External Storage

2 x USB 3.0 Ports

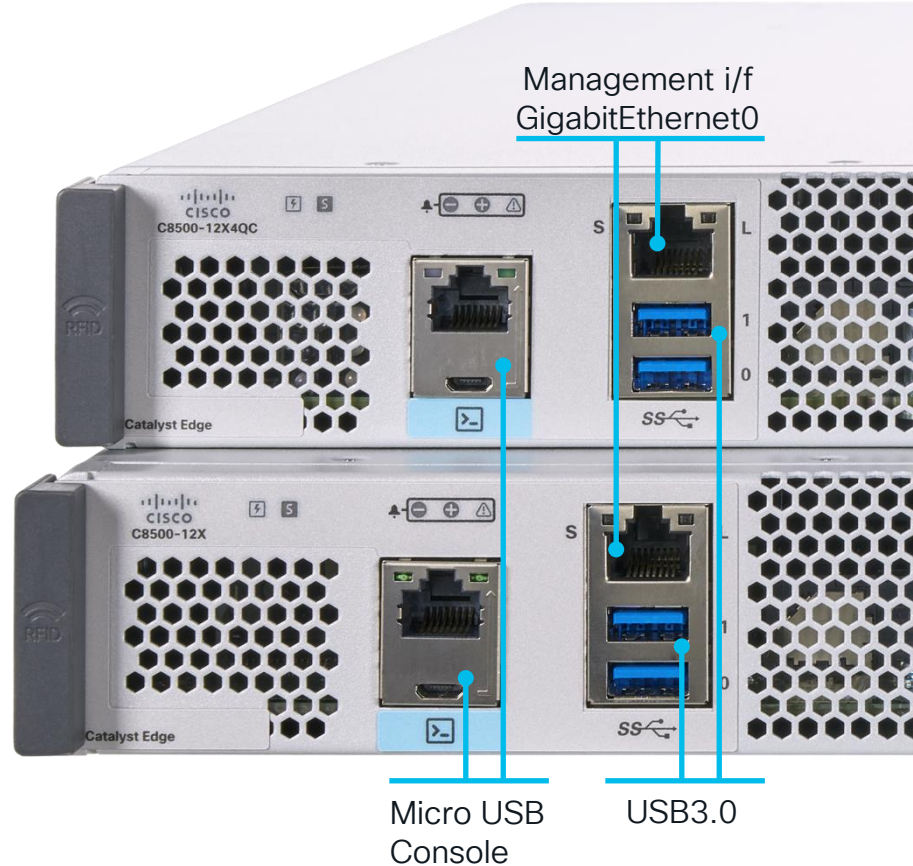

Industrial Design and Ergonomics



Circle Pattern
Hex Packing

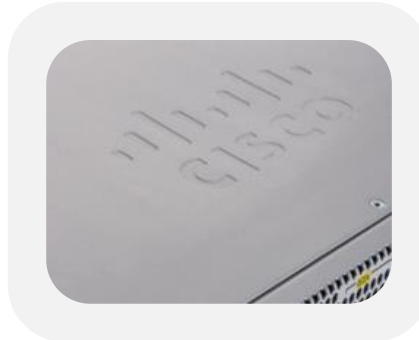

Satin Aluminum Based
Textured Finish



Rounded Frame
4 mm

Catalyst 8500 Software Architecture

CISCO *Live!*



Open IOS XE – A Modern Operating System

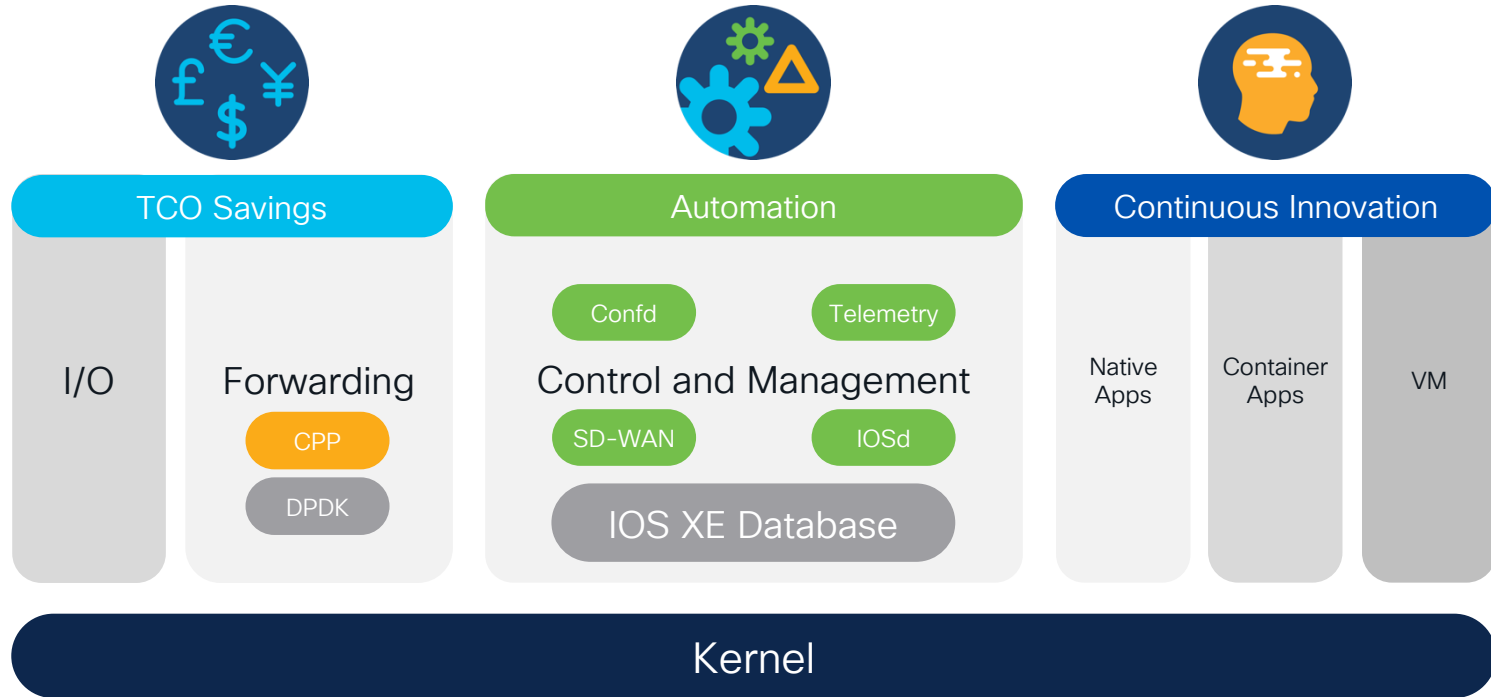

Easy Operations with Single Image



Accelerate SD-WAN



Simplify Deployments



Cloud-scale Applications

Catalyst 8500 Programmability

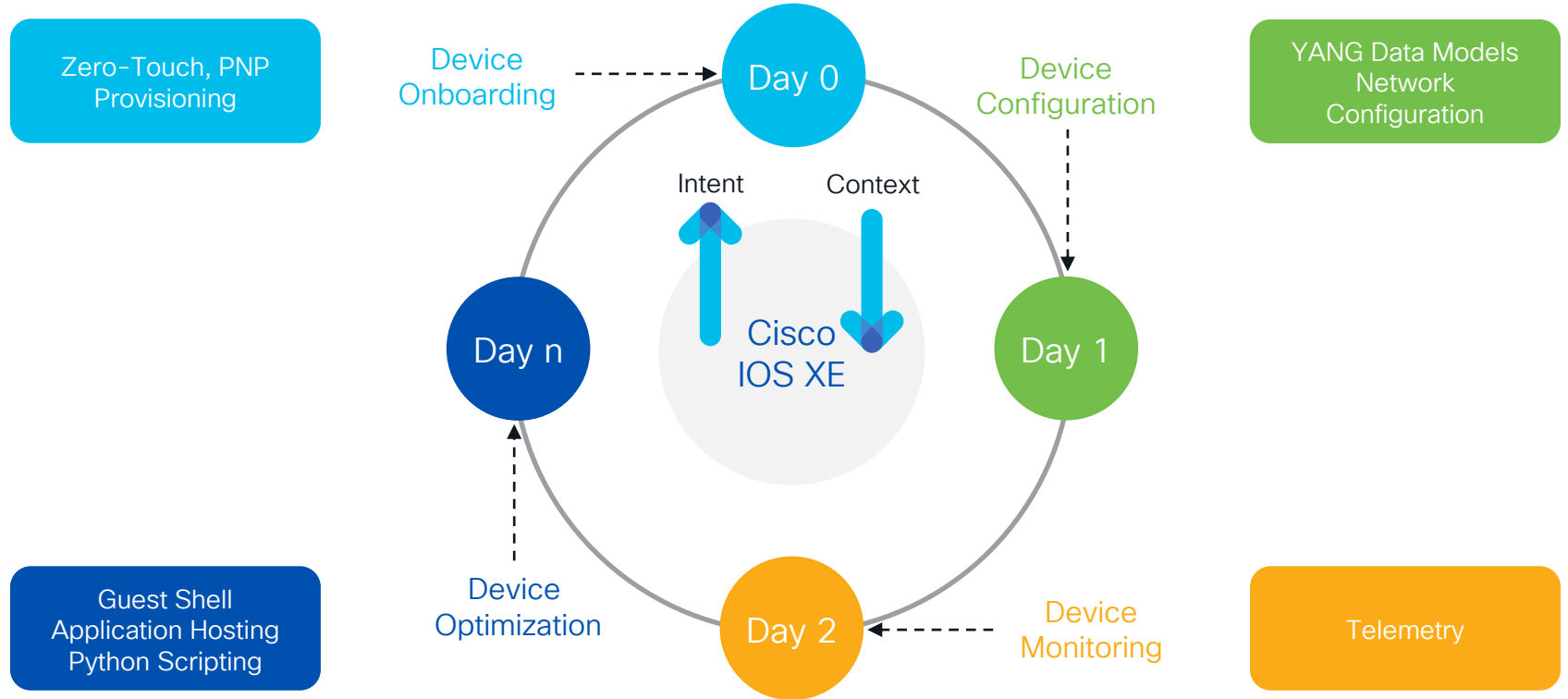

Catalyst 8500 Product Comparison

CISCO *Live!*



Cisco Catalyst 8500 Series Edge Platforms

Highly Capable Routing, SD-WAN Headend



Performance



C8500L-8S4X

CEF: up to 33 Gbps
IPsec: up to 15 Gbps
SD-WAN IPsec: up to 14 Gbps



C8500-12X

CEF: up to 115 Gbps
IPsec: up to 49 Gbps
SD-WAN IPsec: up to 34 Gbps



C8500-12X4QC

CEF: up to 192 Gbps
IPsec: up to 64 Gbps
SD-WAN IPsec: up to 44 Gbps



C8500-20X6C

CEF: up to 538 Gbps
IPsec: up to 225 Gbps
SD-WAN IPsec: up to 160 Gbps

CEF: Autonomous mode
IPsec: Autonomous/Controller mode

All Throughput numbers are Aggregate, 512 B payload

ASR1002-HX vs C8500-12X4QC

Product Comparison

Up to 18Gbps SD-WAN, 6000 tunnels

Up to 100Gbps CEF, 25Gbps Crypto

8M NAT/PAT, 12M CGN Sessions

4GB DP Memory, 232K Queues

Ports: 8x 1G, 8x 10G, One EPA Slot

16GB to 32GB upgradable DRAM

QFP 2.0, 124 Cores, extra Crypto HW

Up to 30Gbps SD-WAN, 8000 tunnels

Up to 189Gbps CEF, 40Gbps Crypto

16M NAT/PAT, 32M CGN Sessions

32GB DP Memory, 256K Queues

Ports: 12x 1/10G, 2x 40/100G, 2x 40G

16GB to 64GB upgradable DRAM

QFP 3.0, 224 Cores, Inbuilt Crypto, L2



All perf numbers are aggregate IMIX throughput

ASR1001-HX vs C8500-12X

Product Comparison

Up to 11Gbps SD-WAN, 6000 tunnels

Up to 60Gbps CEF, 16Gbps Crypto

2M NAT/PAT, 4M CGN Sessions

1GB DP Memory, 116K Queues

Ports: 8x 1G, 4x 10G, 4x 1/10G

16GB to 32GB upgradable DRAM

QFP 2.0, 124 Cores, extra. Crypto HW

Up to 24Gbps SD-WAN, 8000 tunnels

Up to 114Gbps CEF, 34Gbps Crypto

12M NAT/PAT, 24M CGN Sessions

32GB DP Memory, 256K Queues

Ports: 12x 1/10G

16GB to 64GB upgradable DRAM

QFP 3.0, 224 Cores, Inbuilt Crypto, L2



All perf numbers are aggregate IMIX throughput

ASR1001-X vs C8500L-8S4X

Product Comparison

Up to 4.5 Gbps SD-WAN, 6000 tunnels

Up to 20Gbps CEF, 5.5Gbps Crypto

2M NAT/PAT, 15 Gbps NAT perf

4GB DP Memory, 16K Queues

Ports: 6x 1G, 2x 10G

8GB to 32GB upgradable DRAM

QFP 2.0, 31 Cores

Up to 10Gbps SD-WAN, 6000 tunnels

Up to 23Gbps CEF, 12Gbps Crypto

2M NAT/PAT, 17 Gbps NAT perf

Max 4GB DP Memory, 16K Queues

Ports: 8x 1G, 4x 1/10G

16GB to 64GB upgradable DRAM

x86, 12 Cores, Flow Based Architecture

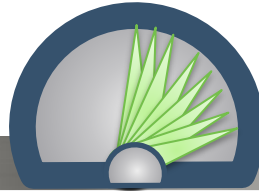

All perf numbers are aggregate IMIX throughput

Solutions, Use-Cases

CISCO *Live!*



C8500 for Cloud-scale SD-WAN

100 / 40 / 10 / 1 GE Ports

High Speed DIA, DCA

Headend Multicast Replication

SASE, Cloud Edge Platform

8000 SD-WAN Tunnels

Remote Workforce Aggregation

High IPsec Throughput

High Performance Services

SD-WAN

Cisco
Umbrella

salesforce



Data Center Hub



Campus Edge



C8500 for Enterprise Networks

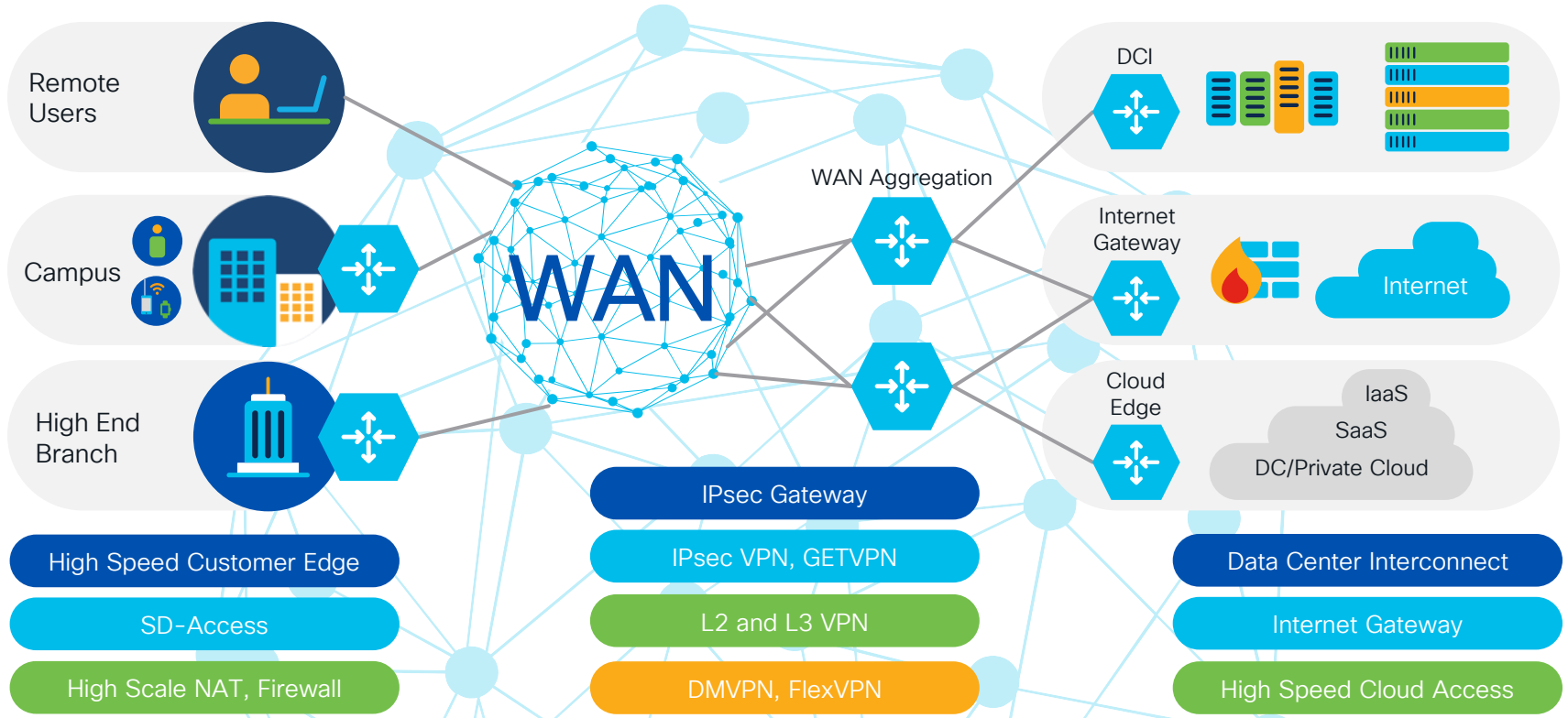

C8500 for Service Provider Networks

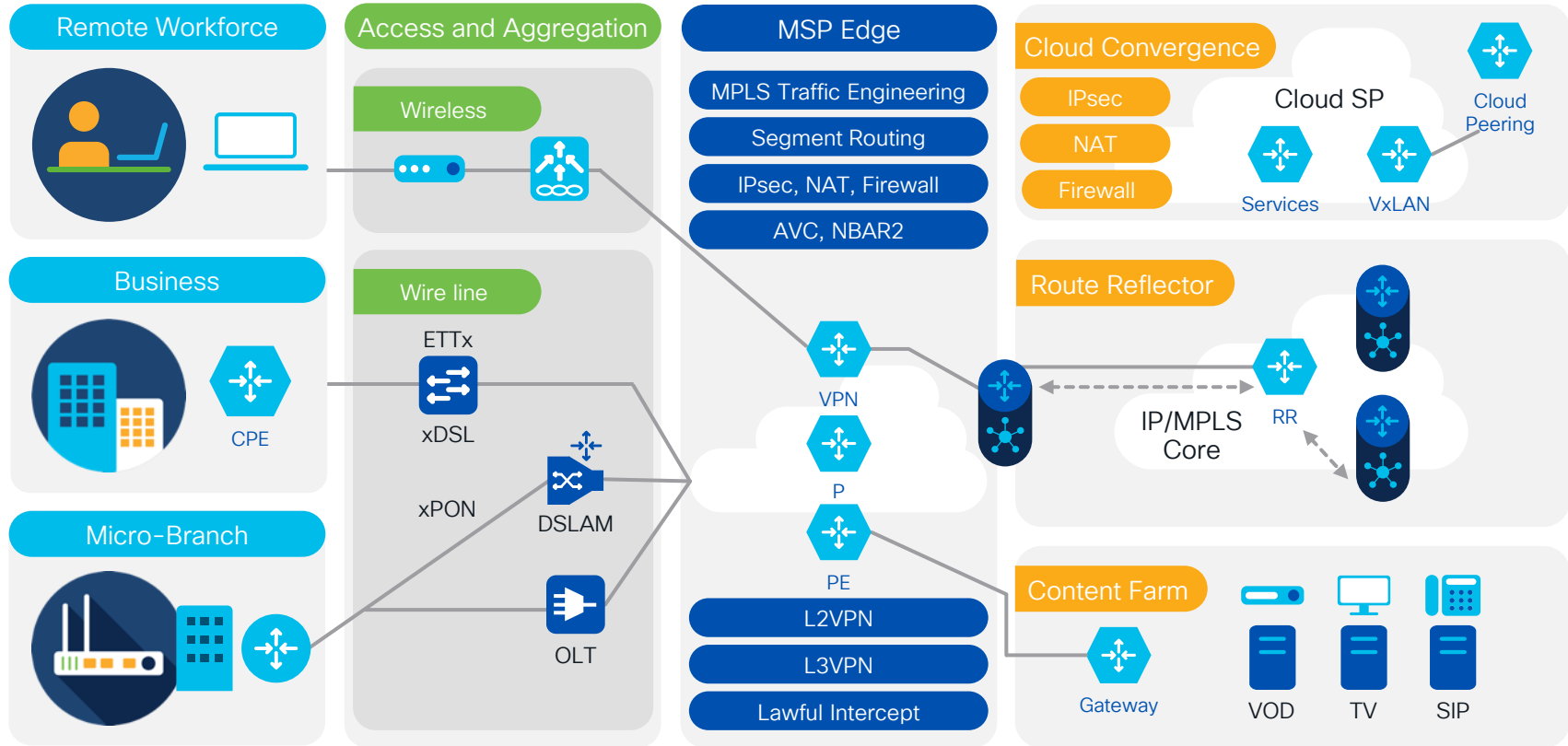

Catalyst 8500: One Platform, Many Solutions



SD-WAN

High Speed DIA, DCA
Multi-Region Fabric BR
Multi-Tenant Edge/Gateway
SD-WAN Remote Access
Multicast Replication

Internet Gateway

High Throughput Performance
NAT44/NAT64/NAT66
AVC, Firewall
High Speed DIA, DCA
Dynamic Application Policy
Routing (DAPR)

Cloud GW, CoLo

Multi-Tenant, VRF Aware
High Scale NAT, AVC, Firewall
Inter VRF Services- VASI
Stateful B2B High Availability
MACsec, IPsec

Secure WAN

Site-to-site, Remote
Access VPN
GETVPN, DMVPN, FlexVPN,
IPsec over GRE, sVTI
High Scale NAT, AVC, Firewall
WAN MACsec

SD-Access

Control-Plane Node
Border Node
SD-Access, SD-WAN
Multi-Domain

DCI

EoMPLS, L2TPv3,
VPLS, MPLS
Overlay Transport
Virtualization
EVPN VXLAN
Cisco WAN MACsec

Network Infra

MPLS, Segment Routing
L2VPN, L3VPN
mVPN
MPLS-TE
AVC, H-QoS
Route Reflector

Cloud MSP

Multi-Tenant, VRF Aware
VXLAN
Route Scale
IPsec, NAT, Firewall
Stateful B2B High Availability

Catalyst 8500

Inherits Cisco ASR 1000 features for IOS XE and IOS XE SD-WAN use-cases

Platform Troubleshooting

CISCO *Live!*



Data Path: Feature Invocation Array – FIA

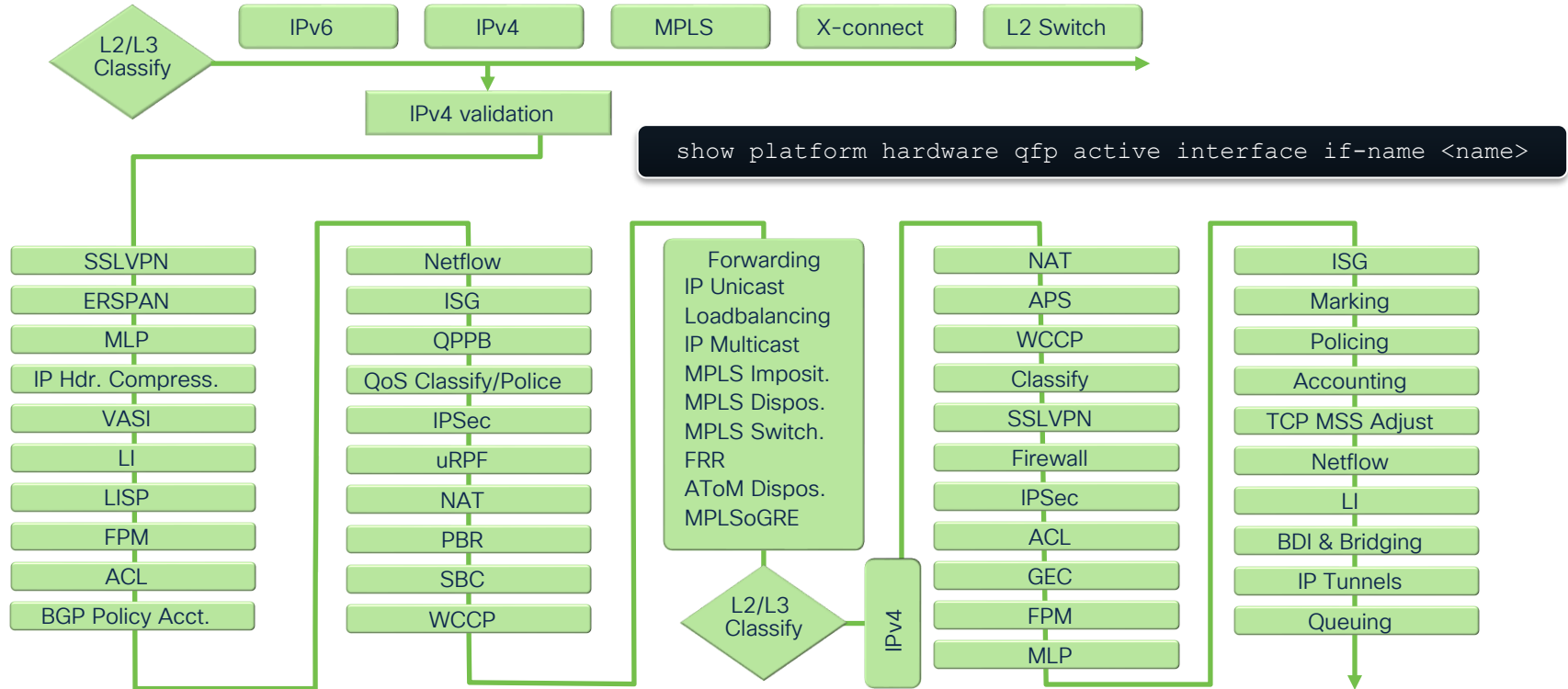

Data Path: Feature Invocation Array – FIA

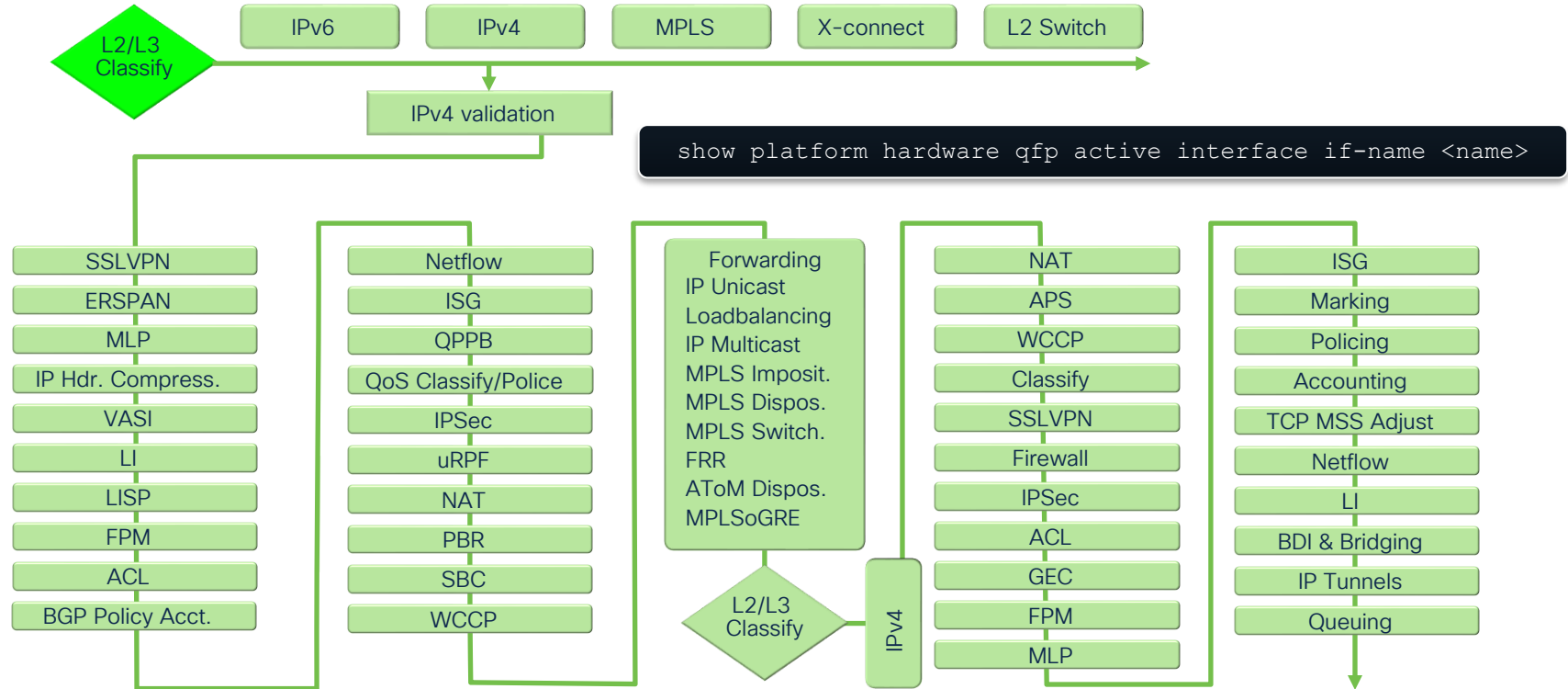

Data Path: Feature Invocation Array – FIA

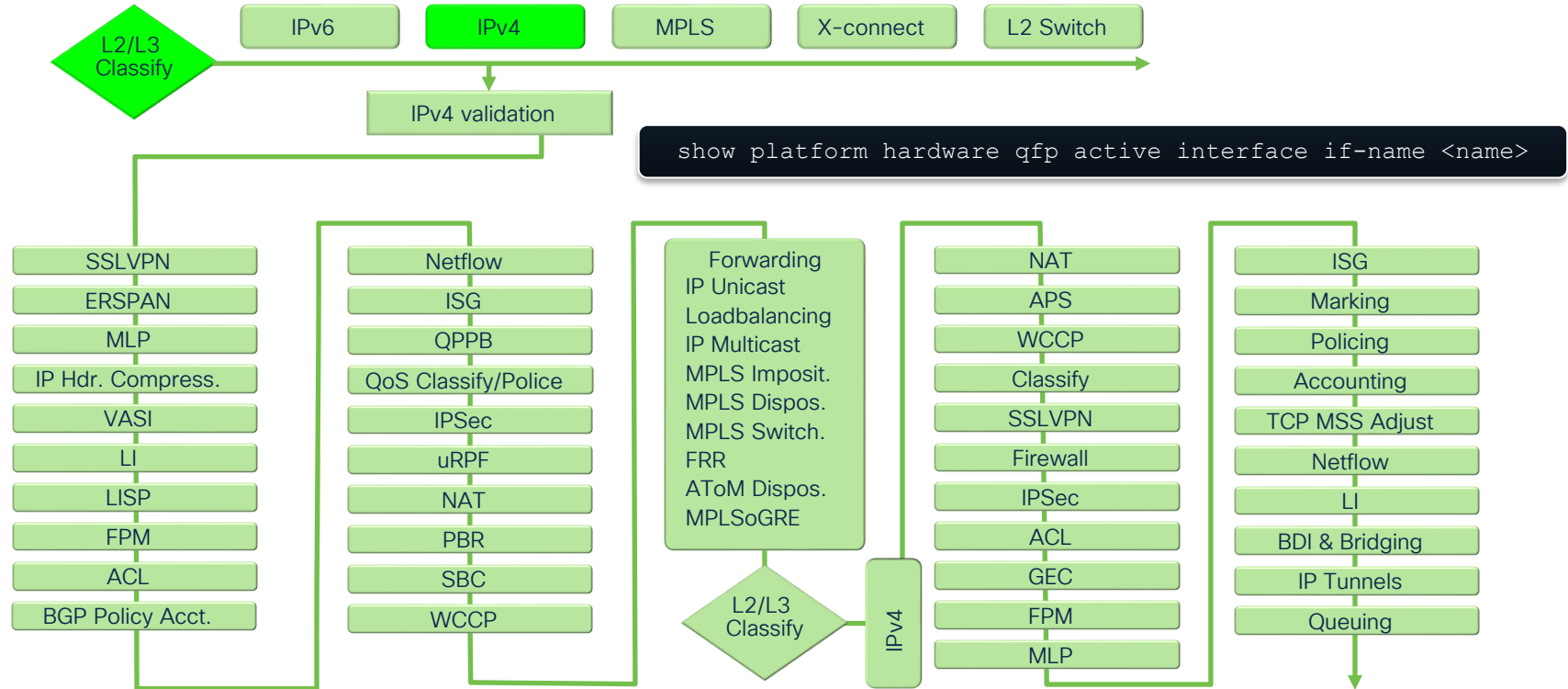

Data Path: Feature Invocation Array – FIA

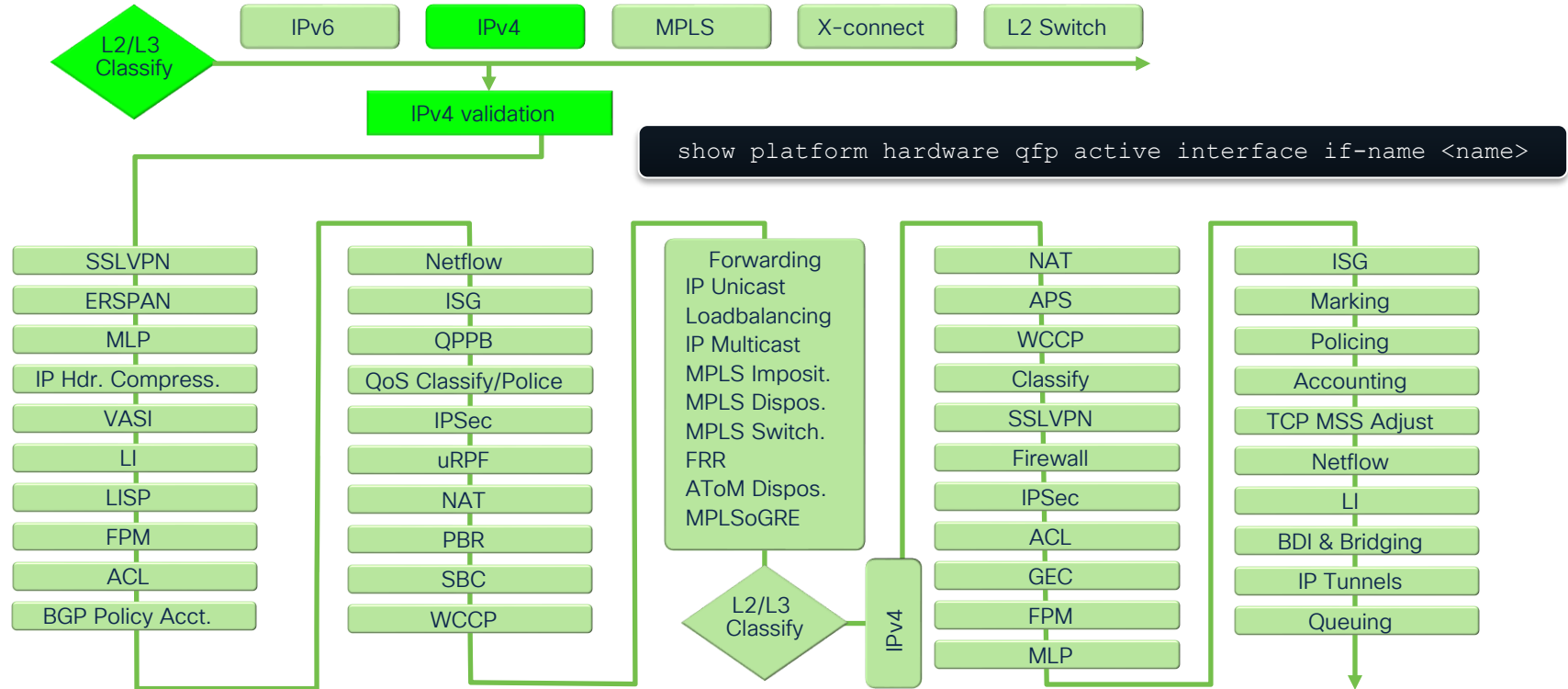

Data Path: Feature Invocation Array – FIA

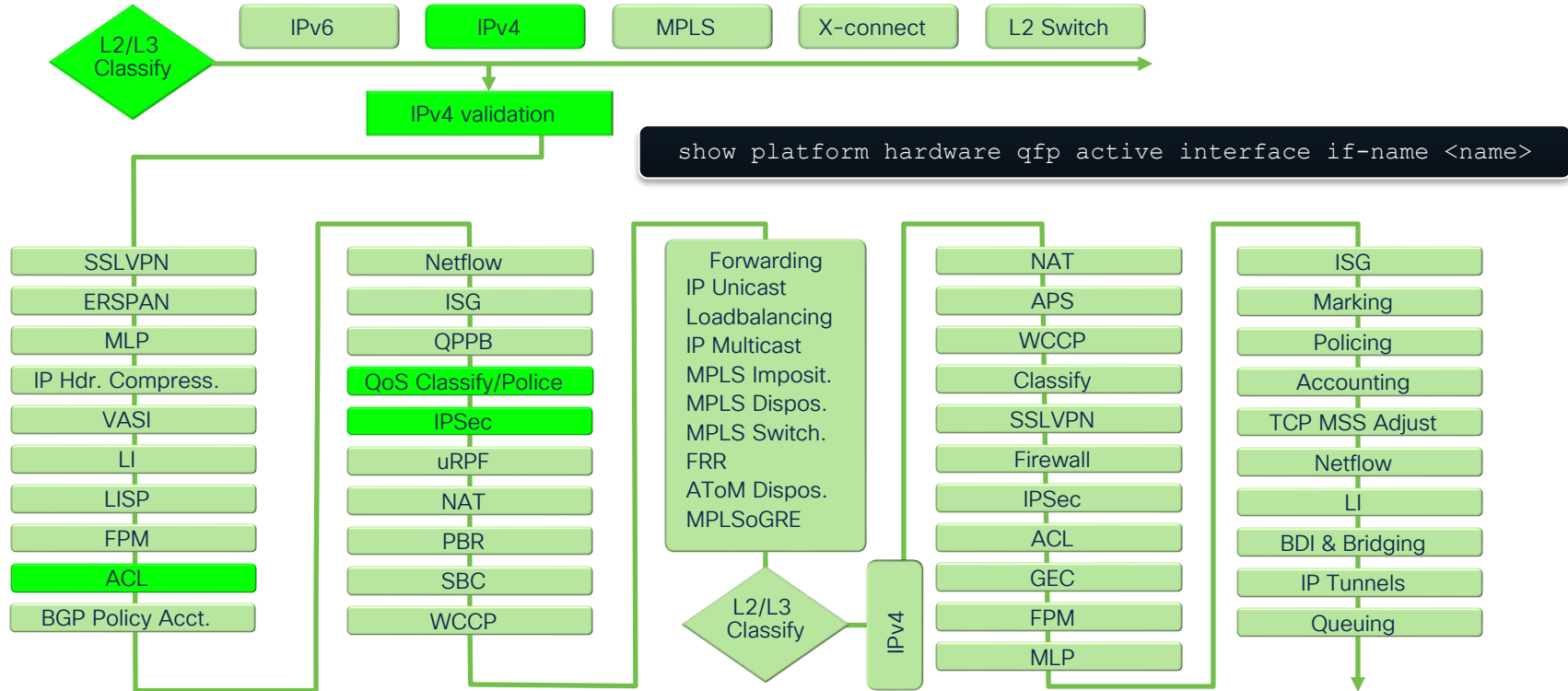

Data Path: Feature Invocation Array – FIA

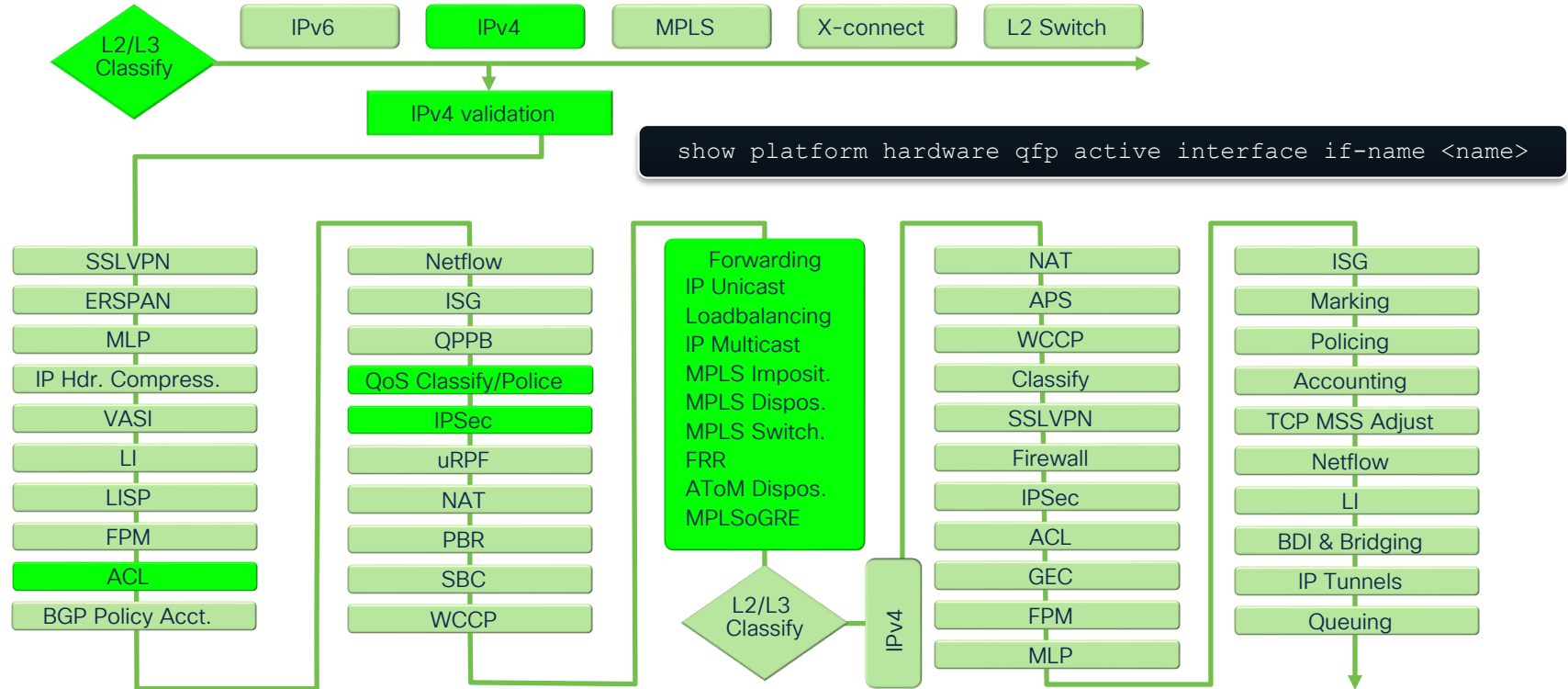

Data Path: Feature Invocation Array – FIA

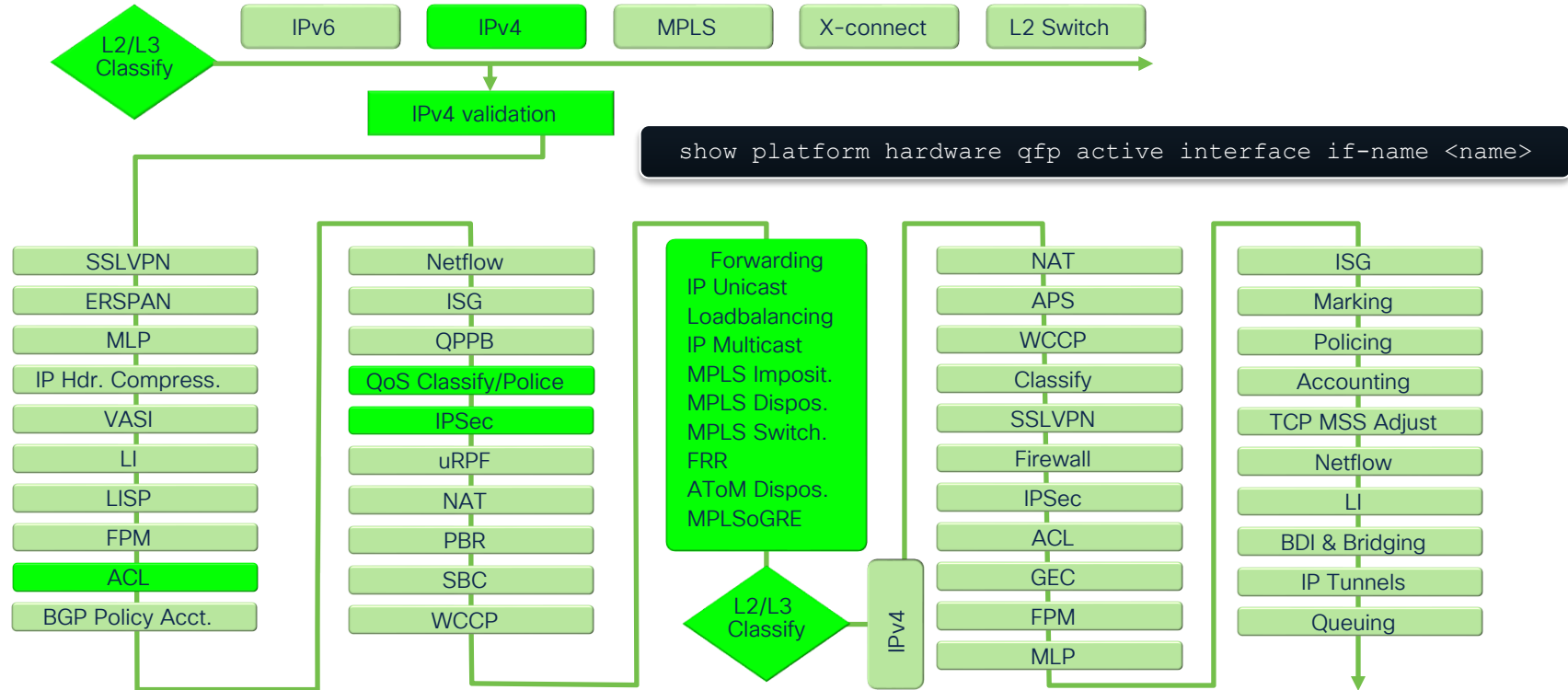

Data Path: Feature Invocation Array – FIA

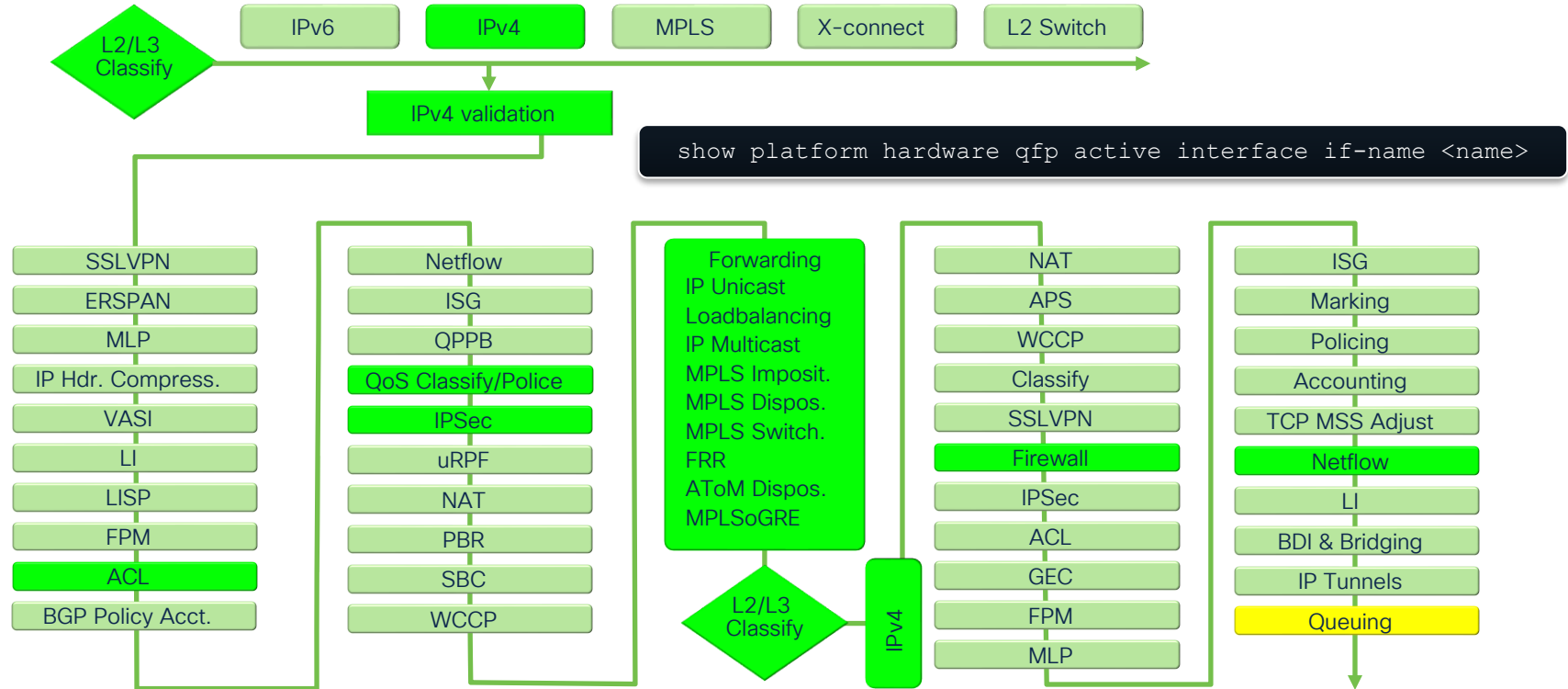

FIA Tracing Demo

CISCO *Live!*





Per Interface FIA



```
C8500# show platform hardware qfp active interface if-name TenGigabitEthernet0/0/1
General interface information
  Interface Name: TenGigabitEthernet0/0/1
  Interface state: VALID
  Platform interface handle: 7
  QFP interface handle: 6
  Rx uidb: 62
  Tx uidb: 262138
  Channel: 7
Interface Relationships

BGPPA/QPPB interface configuration information
  Ingress: BGPPA/QPPB not configured. flags: 0000
  Egress : BGPPA not configured. flags: 0000

ipv4_input enabled.
ipv4_output enabled.
layer2_input enabled.
layer2_output enabled.
ess_ac_input enabled.
```

Features Bound to Interface:

```
 2 GIC FIA state
65 PUNT INJECT DB
51 ethernet
50 SPA/Marmot server
 1 IFM
42 icmp_svr
44 ipfrag_svr
45 ipreass_svr
47 ipvfr_svr
19 nat_svr
Protocol 0 - ipv4_input
FIA handle - CP:0x55945b1419a0 DP:0x3ffe0000
  IPV4_INPUT_DST_LOOKUP_ISSUE (M)
  IPV4_INPUT_ARL_SANITY (M)
  IPV4_INPUT_DST_LOOKUP_CONSUME (M)
  IPV4_INPUT_FOR_US_MARTIAN (M)
  IPV4_INPUT_VFR
  IPV4_NAT_INPUT_FIA
<snip>
```

Gives the feature invocation array information on ingress and egress of forwarding plane configuration for the interface

Conditional FIA Tracing Steps



```
C8500#debug platform condition ?
  application  Debug Application conditions
  both         Simultaneous ingress and egress debug
  egress       Egress only debug
  feature      For a specific feature
  ingress      Ingress only debug
  interface    Set interface for condition
  ipv4         Debug IPv4 conditions
  ipv6         Debug IPv6 conditions
  mac          Debug MAC conditions
  match        Describe inline acl filter
  mpls         Debug MPLS conditions
  start        Start conditional debug
  stop         Stop conditional debug
```

```
C8500#debug platform packet-trace ?
  copy         Copy packet data
  drop         Trace drops only
  inject       Trace injects only
  packet       Packet count
  punt         Trace punts only
  statistics   enable packet trace statistics
```

```
C8500#
```

FIA trace helps visibility of complex services application in data plane of C8500 platforms.
Also helps nano second level traffic processing insights per FIA.

Step 1: Enable QFP packet trace

```
C8500# debug platform packet-trace packet 128 circular fia-trace
C8500# debug platform packet-trace copy packet input size 2048 L2
```

Step 2: Set platform debug condition

```
C8500# debug platform condition ipv4 access-list temp both
```

Step 3: Start the debug- trigger the packet tracing

```
C8500# debug platform condition start
```

Step 4: Stop the debug

```
C8500# debug platform condition stop
```

Step 5: Collect the packet trace information

```
C8500# show platform packet-trace summary
C8500# show platform packet-trace packet all
```

Conditional FIA Tracing



```
C8500# show platform packet-trace statistics
Packets Traced: 5
Ingress 5
Inject 0
Forward 5
Punt 0
Drop 0
Consume 0
```

```
C8500#show platform packet-trace summary
Pkt Input Output State Reason
0 Gi0/0/1 Gi0/0/0 FWD
1 Gi0/0/1 Gi0/0/0 FWD
2 Gi0/0/1 Gi0/0/0 FWD
3 Gi0/0/1 Gi0/0/0 FWD
4 Gi0/0/1 Gi0/0/0 FWD

C8500#
```

Summary level and per packet level FIA tracing possible
Also enables to get hex dump of ingress and egress packet as seen by QFP

```
C8500# show platform packet-trace packet 0
Packet: 0 CBUG ID: 4
Summary
Input : GigabitEthernet0/0/1
Output : GigabitEthernet0/0/0
State : FWD
Timestamp
  Start   : 1819281992118 ns (05/17/2014 06:42:01.207240
UTC)
  Stop    : 1819282095121 ns (05/17/2014 06:42:01.207343
UTC)
Path Trace
Feature: IPV4
Source : 172.16.10.2
Destination : 172.16.20.2
Protocol : 1 (ICMP)
```

Platform Resource Summary



```
C8500# show platform resources
```

```
**State Acronym: H - Healthy, W - Warning, C - Critical
```

| Resource | Usage | Max | Warning | Critical | State |
|-------------------|---------------|-------------|---------|----------|-------|
| ----- | | | | | |
| RP0 (ok, active) | | | | | H |
| Control Processor | 2.82% | 100% | 80% | 90% | H |
| DRAM | 3014MB (19%) | 15565MB | 88% | 93% | H |
| bootflash | 1287MB (5%) | 25725MB | 88% | 93% | H |
| harddisk | 0MB (0%) | 0MB | 88% | 93% | H |
| ESP0 (ok, active) | | | | | H |
| QFP | | | | | H |
| TCAM | 8cells (0%) | 131072cells | 65% | 85% | H |
| DRAM | 356927KB (1%) | 20971520KB | 85% | 95% | H |
| IRAM | 16597KB (12%) | 131072KB | 85% | 95% | H |
| CPU Utilization | 0.00% | 100% | 90% | 95% | H |
| Pkt Buf Mem (0) | 1152KB (0%) | 164864KB | 85% | 95% | H |
| Pkt Buf CBlk (0) | 14544KB (1%) | 986112KB | 85% | 95% | H |

```
C8500#
```

A system wide platform resource summary command- show platform resources. It covers most of the critical resources.

Software Status- Control Processor



```
C8500# show platform software status control-processor brief
```

Load Average

| Slot | Status | 1-Min | 5-Min | 15-Min |
|------|---------|-------|-------|--------|
| RP0 | Healthy | 0.27 | 0.21 | 0.16 |

Memory (kB)

| Slot | Status | Total | Used (Pct) | Free (Pct) | Committed (Pct) |
|------|---------|----------|---------------|----------------|-----------------|
| RP0 | Healthy | 15939320 | 3081200 (19%) | 12858120 (81%) | 9046624 (57%) |

CPU Utilization

| Slot | CPU | User | System | Nice | Idle | IRQ | SIRQ | IOwait |
|------|-----|------|--------|------|-------|------|------|--------|
| RP0 | 0 | 0.60 | 0.40 | 0.00 | 99.00 | 0.00 | 0.00 | 0.00 |
| | 1 | 0.09 | 0.19 | 0.00 | 99.60 | 0.00 | 0.09 | 0.00 |
| | 2 | 0.49 | 0.39 | 0.00 | 99.00 | 0.00 | 0.09 | 0.00 |
| | 3 | 0.20 | 0.20 | 0.00 | 99.59 | 0.00 | 0.00 | 0.00 |
| | 4 | 0.50 | 0.40 | 0.00 | 99.10 | 0.00 | 0.00 | 0.00 |
| | 5 | 0.10 | 0.20 | 0.00 | 99.69 | 0.00 | 0.00 | 0.00 |
| | 6 | 0.20 | 0.20 | 0.00 | 99.59 | 0.00 | 0.00 | 0.00 |
| | 7 | 2.40 | 0.70 | 0.00 | 96.80 | 0.00 | 0.10 | 0.00 |

```
C8500#
```

Alerts

%PLATFORM-4-ELEMENT_WARNING

→ Look out for committed memory

%OOM-0-NO_MEMORY_RESET:

→ System is completely out of memory

%OOM-3-NO_MEMORY_AVAIL:

→ System is low on available memory

IOSd CPU Consumption



```
C8500# show processes cpu sorted
CPU utilization for five seconds: 5%/1%; one minute: 4%; five minutes: 6%
PID Runtime(ms)   Invoked    uSecs   5Sec   1Min   5Min  TTY Process
547   2834655       39762575   71     1.59%  1.49%  2.26%  0 DHCP Client
132   1162320       63935111   18     0.39%  0.38%  0.52%  0 IOSXE-RP Punt Se
 16   202269        14022331   14     0.23%  0.11%  0.15%  0 ARP Background
136   34870         9778096    3     0.07%  0.01%  0.00%  0 L2 LISP Punt Pro
193   15778         4899375    3     0.07%  0.01%  0.00%  0 IP ARP Retry Age
287   192338        9226684    20    0.07%  0.10%  0.15%  0 IP Connected Rou
 87   166228        1074530    154   0.07%  0.09%  0.12%  0 IOSD ipc task
312   47348         9226664    5     0.07%  0.02%  0.04%  0 static
  8     0             1          0     0.00%  0.00%  0.00%  0 RO Notify Timers
  7     0             1          0     0.00%  0.00%  0.00%  0 EDDRI_MAIN
  9   56128        21294     2635  0.00%  0.02%  0.00%  0 Check heaps
 10    122         2618      46   0.00%  0.00%  0.00%  0 Pool Manager
 13     1           519      1   0.00%  0.00%  0.00%  0 WATCH_AFS
 11     0             1          0   0.00%  0.00%  0.00%  0 DiscardQ Backgro
 15   17481        624562    27   0.00%  0.00%  0.00%  0 ARP Input
 12     0             2          0   0.00%  0.00%  0.00%  0 Timers
 14     0             1          0   0.00%  0.00%  0.00%  0 MEMLEAK PROCESS
 18     0             1          0   0.00%  0.00%  0.00%  0 ATM ASYNC PROC
--More--
```

'show process cpu history' CLI can be used to check CPU history for last 60 sec, 60 min and 72 hr timeframe.

IOSd Memory Consumption



```
C8500# show processes memory sorted
Processor Pool Total: 6992665708 Used: 292428256 Free: 6700237452
reserve P Pool Total: 102404 Used: 88 Free: 102316
lsmpi_io Pool Total: 6295128 Used: 6294296 Free: 832
```

```
PID TTY Allocated Freed Holding Getbufs Retbufs Process
0 0 396181608 150330672 227209592 0 0 *Init*
6 0 20375344 83272 20248296 0 0 RF Slave Main Th
87 0 15950264 4032 10648104 0 0 IOSD ipc task
407 0 4130152 60792 4111304 849828 0 EEM ED Syslog
0 0 25398869344 24998765496 3705144 26263479 0 *Dead*
428 0 1800720 43416 1787248 0 0 EEM Server
1 0 1221440 0 1251384 0 0 Chunk Manager
172 0 4257424 1186136 1149320 0 0 CWAN OIR Handler
83 0 12819728 11931096 942200 0 0 SASRcvWQWrk1
291 0 938720 55456 934344 0 0 CEF: IPv4 proces
192 0 802472 0 856416 0 0 IP ARP Adjacency
388 0 2085144 1421248 665960 0 0 Crypto CA
197 0 838704 344792 493320 0 0 mDNS
408 0 396968 9584 429328 72316 0 EEM ED Generic
145 0 3615981024 3615601760 422512 0 0 SAMsgThread
--More--
```

This CLI helps to identify the process level memory consumption within IOS daemon.

Linux level (top) CPU, Memory Usage



```
C8500# show platform software process slot rp active monitor
top - 23:30:18 up 1 day, 20:26,  0 users,  load average: 0.12, 0.06, 0.06
Tasks: 321 total,  2 running, 319 sleeping,  0 stopped,  0 zombie
%Cpu(s):  0.0 us,  0.8 sy,  0.0 ni, 99.2 id,  0.0 wa,  0.0 hi,  0.0 si,  0.0 st
MiB Mem : 15565.7 total, 10045.3 free,  1572.0 used,  3948.4 buff/cache
MiB Swap:   0.0 total,   0.0 free,   0.0 used. 13419.9 avail Mem
```

| PID | USER | PR | NI | VIRT | RES | SHR | S | %CPU | %MEM | TIME+ | COMMAND |
|-------|------|----|-----|--------|-------|-------|---|------|------|---------|------------|
| 14821 | root | 20 | 0 | 303276 | 35012 | 29148 | S | 6.2 | 0.2 | 0:51.70 | psd |
| 1 | root | 20 | 0 | 10088 | 8088 | 5592 | S | 0.0 | 0.1 | 0:29.54 | systemd |
| 2 | root | 20 | 0 | 0 | 0 | 0 | S | 0.0 | 0.0 | 0:00.05 | kthreadd |
| 3 | root | 0 | -20 | 0 | 0 | 0 | I | 0.0 | 0.0 | 0:00.00 | rcu_gp |
| 4 | root | 0 | -20 | 0 | 0 | 0 | I | 0.0 | 0.0 | 0:00.00 | rcu_par_gp |
| 6 | root | 0 | -20 | 0 | 0 | 0 | I | 0.0 | 0.0 | 0:00.00 | kworker/0+ |
| 8 | root | 0 | -20 | 0 | 0 | 0 | I | 0.0 | 0.0 | 0:00.00 | mm_percpu+ |
| 9 | root | 20 | 0 | 0 | 0 | 0 | S | 0.0 | 0.0 | 0:01.26 | ksoftirqd+ |
| 10 | root | 20 | 0 | 0 | 0 | 0 | I | 0.0 | 0.0 | 1:04.07 | rcu_sched |
| 11 | root | 20 | 0 | 0 | 0 | 0 | I | 0.0 | 0.0 | 0:00.03 | rcu_bh |
| 12 | root | rt | 0 | 0 | 0 | 0 | S | 0.0 | 0.0 | 0:00.47 | migration+ |
| 13 | root | 20 | 0 | 0 | 0 | 0 | S | 0.0 | 0.0 | 0:00.00 | cpuhp/0 |
| 14 | root | 20 | 0 | 0 | 0 | 0 | S | 0.0 | 0.0 | 0:00.00 | cpuhp/1 |

--More--

This CLI helps to verify Linux level memory and CPU consumption like 'top' command.

Data Plane: TCAM Consumption



```
C8500# show platform hardware qfp active tcam resource-manager usage
QFP TCAM Usage Information
```

80 Bit Region Information

```
Name : Leaf Region #1
Number of cells per entry : 1
Current 80 bit entries used : 0
Current used cell entries : 0
Current free cell entries : 0
```

160 Bit Region Information

```
Name : Leaf Region #2
Number of cells per entry : 2
Current 160 bits entries used : 4
Current used cell entries : 8
Current free cell entries : 4088
```

320 Bit Region Information

```
Name : Leaf Region #2
Number of cells per entry : 4
Current 320 bits entries used : 0
Current used cell entries : 0
Current free cell entries : 0
```

Total TCAM Cell Usage Information

```
Name : TCAM #0 on CPP #0
Total number of regions : 3
Total tcam used cell entries : 8
Total tcam free cell entries : 131064
Threshold status : below critical limit
```

```
C8500#
```

Note: C8500L platform does not have dedicated TCAM memory.

TCAM is very important resource for classification configuration, should always be below critical limit.
%CPP_FM-3-CPP_FM_TCAM_WARNING → TCAM exhaustion warning syslog

Data Plane: QFP Memory Statistics



```
C8500# show platform hardware qfp active infrastructure exmem statistics
QFP exmem statistics
```

```
Type: Name: DRAM, QFP: 0
  Total: 21474836480
  InUse: 365493248
  Free: 21109343232
  Lowest free water mark: 21108950016
Type: Name: IRAM, QFP: 0
  Total: 134217728
  InUse: 16995328
  Free: 117222400
  Lowest free water mark: 117222400
Type: Name: SRAM, QFP: 0
  Total: 0
  InUse: 0
  Free: 0
  Lowest free water mark: 0
```

```
C8500#
```

Alerts

%CPPDRV-3-FATAL_MEM_SIZE
→ Software failed to acquire memory

%CPPEXMEM-3-NOMEM
→ CPP memory resource exhaustion

%CPPEXMEM-4-LOWMEM
→ CPP memory resource dropped below
critical level

%CPPEXMEM-5-MEM
→ CPP memory resource has recovered

Data Plane: BQS DRAM Utilization



```
C8500# show platform hardware qfp active bqs 0 packet-buffer utilization
```

```
Packet buffer memory utilization details:
```

```
QFP.0:
```

```
Total:      161.00 MB
:           963.00 MB cblk
Used :      1152.00 KB
:          14544.00 KB cblk
Free  :      159.88 MB
:           948.80 MB cblk
```

```
Utilization: 0 %
:            1 % cblk
```

```
Threshold Values:
```

```
Vital          : 160.94 MB, Status: False
                : 962.91 MB cblk
Packet Priority : 159.44 MB, Status: False
                : 953.39 MB cblk
Priority        : 152.94 MB, Status: False
                : 914.81 MB cblk
Non-Priority   : 136.81 MB, Status: False
                : 818.44 MB cblk
```

```
C8500#
```

Alerts

```
%CPPBQS-4-QLIMITEXCEEDED
```

```
→ Max number of queues exceeded
```

```
%CPPBQS-6-QLIMITOK
```

```
→ Queues usage is within platform limit
```

```
%CPP_BQS-3-CARVE
```

```
→ BQS proxy failed to initialize software  
memory region
```

Data Plane: BQS Queue and Schedules



```
C8500# show platform hardware qfp active infrastructure bqs status
BQS-RM Status :
=====
Object Counts:
  Recycle Object Count:          148
  Recycle Schedule Count:        26
  Recycle Queue Count:           88
  # of Active Queues:            517
  # of Active Schedules:         533
  # of Active Roots:             12
  # of Active Min Profiles:       12
  # of Active Max Profiles:        6
  # of Active Exs Profiles:        8
Configuration Status:
  Pending Config Deferred:        False
  Pending Config Deferred Cnt:    4109
  OOR defer processing             False
<snip>
```

This CLI helps to to check current active queues in use and scheduler nodes associated with it.

Data Plane: QFP Utilization



```
C8500# show platform hardware qfp active datapath utilization
  CPP 0: Subdev 0          5 secs          1 min          5 min          60 min
Input:  Priority (pps)      0                0                0                0
        (bps)              0                0                0                0
      Non-Priority (pps)   844658           844653           844655           844646
        (bps)             851392584        851385576        851387240        851383656
      Total (pps)         844658           844653           844655           844646
        (bps)             851392584        851385576        851387240        851383656
Output: Priority (pps)     31               37               39               28
        (bps)             24264            28504            29872            21696
      Non-Priority (pps)  844781           844702           844703           844692
        (bps)             975232920        974111680        974112760        974106624
      Total (pps)         844812           844739           844742           844720
        (bps)             975232920        974111680        974112760        974106624
Processing: Load (pct)  975
```

CISCO-ENTITY-QFP-MIB

Cisco-IOS-XE-qfp-stats-oper.yang
Cisco-IOS-XE-qfp-stats.yang
Cisco-IOS-XE-qos.yang

```
C8500#
```

```
C8500# show platform hardware qfp active datapath utilization summary
  CPP 0:          5 secs          1 min          5 min          60 min
Input:   Total (pps)      844647          844657          844657          844646
        (bps)           851382464        851388832        851389088        851383528
Output:  Total (pps)      844801          844744          844744          844720
        (bps)           975243928        974144656        974144784        974127888
Processing: Load (pct)    4                4                4                4
```

```
C8500#
```

Data Plane: Crypto Utilization



```
C8500# show platform hardware crypto-device statistics
Forwarding Manager Encryption-processor Statistics
```

(P) - # of packets; (B) - # of bytes

```
STX1 disabled
TOTAL_CORES      : 0x000006
ENABLED_CORES    : 00000000
AVAILABLE_CORES  : 00000000
OK SPI1 RX(P)    :
ERR SPI1 RX(P)   :
DROP SPI1 RX(P)  :
OK PCI RX(P)     :
PROCESSED(P)     :
ENCRYPTED(P)      :
DECRYPTED(P)      :
GEN. PURPOSE(P)  :
```

```
C8500#
```

Dedicated commands to check
Crypto device statistics, utilization on
the platform.

```
C8500# show platform hardware crypto-device utilization
```

Past crypto device utilization:
utilization is for each crypto device, pkts are combined number.

```
1 min (percentage) : 0%
      (decrypt pkt): 0
      (encrypt pkt): 0
5 min (percentage) : 0%
      (decrypt pkt): 0
      (encrypt pkt): 0
15 min (percentage) : 0%
      (decrypt pkt): 0
      (encrypt pkt): 0
```

```
C8500#
```

Data Plane: x86 Per Core Utilization



```
C8500L#show platform hardware qfp active datapath infrastructure sw-cio
Credits Usage:
```

| ID | Port | Wght | Global | WRKR0 | WRKR1 | WRKR2 | WRKR3 | WRKR4 | WRKR5 | WRKR6 | WRKR7 | WRKR8 | WRKR9 | Total |
|----|-----------|------|--------|-------|-------|-------|-------|-------|-------|-------|-------|-------|-------|-------|
| 1 | rc10 | 1: | 6048 | 0 | 0 | 0 | 0 | 0 | 0 | 96 | 0 | 0 | 0 | 61 |
| 1 | rc10 | 128: | 6048 | 0 | 0 | 0 | 0 | 0 | 0 | 96 | 0 | 0 | 0 | |
| 2 | ipc | 1: | 0 | 0 | 0 | 0 | 0 | 0 | 0 | 0 | 0 | 0 | 0 | |
| 3 | vxe_punti | 1: | 476 | 0 | 0 | 0 | 0 | 0 | 0 | 36 | 0 | 0 | 0 | |
| 4 | fpe0 | 1: | 1952 | 0 | 0 | 0 | 0 | 0 | 0 | 96 | 0 | 0 | 0 | 20 |
| 4 | fpe0 | 2: | 1952 | 0 | 0 | 0 | 0 | 0 | 0 | 96 | 0 | 0 | 0 | 20 |
| 5 | fpe1 | 1: | 1952 | 0 | 0 | 0 | 0 | 0 | 0 | 96 | 0 | 0 | 0 | 20 |
| 5 | fpe1 | 2: | 1952 | 0 | 0 | 0 | 0 | 0 | 0 | 96 | 0 | 0 | 0 | 20 |
| 6 | fpe2 | 1: | 1952 | 0 | 0 | 0 | 0 | 0 | 0 | 96 | 0 | 0 | 0 | 20 |
| 6 | fpe2 | 2: | 1952 | 0 | 0 | 0 | 0 | 0 | 0 | 96 | 0 | 0 | 0 | 20 |
| 7 | fpe3 | 1: | 1953 | 0 | 0 | 0 | 0 | 0 | 0 | 95 | 0 | 0 | 0 | 20 |
| 7 | fpe3 | 2: | 1952 | 0 | 0 | 0 | 0 | 0 | 0 | 96 | 0 | 0 | 0 | 20 |
| 8 | fpe4 | 1: | 1952 | 0 | 0 | 0 | 0 | 0 | 0 | 96 | 0 | 0 | 0 | 20 |
| 8 | fpe4 | 2: | 1952 | 0 | 0 | 0 | 0 | 0 | 0 | 96 | 0 | 0 | 0 | 20 |
| 9 | fpe5 | 1: | 1952 | 0 | 0 | 0 | 0 | 0 | 0 | 96 | 0 | 0 | 0 | 20 |
| 9 | fpe5 | 2: | 1952 | 0 | 0 | 0 | 0 | 0 | 0 | 96 | 0 | 0 | 0 | 20 |
| 10 | fpe6 | 1: | 1952 | 0 | 0 | 0 | 0 | 0 | 0 | 96 | 0 | 0 | 0 | 2 |
| 10 | fpe6 | 2: | 1952 | 0 | 0 | 0 | 0 | 0 | 0 | 96 | 0 | 0 | 0 | 2048 |
| 11 | fpe7 | 1: | 1952 | 0 | 0 | 0 | 0 | 0 | 0 | 96 | 0 | 0 | 0 | 2048 |
| 11 | fpe7 | 2: | 1952 | 0 | 0 | 0 | 0 | 0 | 0 | 96 | 0 | 0 | 0 | 2048 |
| 12 | fpe8 | 1: | 2012 | 0 | 0 | 0 | 0 | 0 | 0 | 36 | 0 | 0 | 0 | 2048 |
| 12 | fpe8 | 2: | 1952 | 0 | 0 | 0 | 0 | 0 | 0 | 96 | 0 | 0 | 0 | 2048 |
| 13 | fpe9 | 1: | 1952 | 0 | 0 | 0 | 0 | 0 | 0 | 96 | 0 | 0 | 0 | 2048 |
| 13 | fpe9 | 2: | 1952 | 0 | 0 | 0 | 0 | 0 | 0 | 96 | 0 | 0 | 0 | 2048 |
| 14 | fpe10 | 1: | 1952 | 0 | 0 | 0 | 0 | 0 | 0 | 96 | 0 | 0 | 0 | 2048 |
| 14 | fpe10 | 2: | 1952 | 0 | 0 | 0 | 0 | 0 | 0 | 96 | 0 | 0 | 0 | 2048 |
| 15 | fpe11 | 1: | 1979 | 0 | 0 | 0 | 0 | 0 | 0 | 69 | 0 | 0 | 0 | 2048 |
| 15 | fpe11 | 2: | 1952 | 0 | 0 | 0 | 0 | 0 | 0 | 96 | 0 | 0 | 0 | 2048 |

PP: Packet Processing
 RX: Receive core
 TM: Traffic Manager core
 COFF: Crypto core

Core Utilization over preceding 604610.7457 seconds

```
-----
ID: 0 1 2 3 4 5 6 7 8 9
% PP: 36.58 69.20 74.43 39.66 72.78 76.07 0.00 0.00 0.00 0.00
% RX: 0.00 0.00 0.00 0.00 0.00 0.00 0.00 28.43 4.86 0.00 0.00
% TM: 0.00 0.00 0.00 0.00 0.00 0.00 0.00 70.81 17.48 0.00 0.00
% COFF: 0.00 0.00 0.00 0.00 0.00 0.00 0.00 0.00 0.00 0.27 0.27
% IDLE: 63.42 30.80 25.57 60.34 27.22 23.93 0.76 77.65 99.73 99.73
```



Data Plane: QFP drops

Global vs Interface level

```
C8500# show platform hardware qfp active statistics drop
Last clearing of QFP drops statistics : Sat Feb 13 00:56:12 2021
(1d 22h 44m 54s ago)
```

```
-----
Global Drop Stats                                Packets                                Octets
-----
BadUidbSubIdx                                   1885726                                120686464
Ipv4NoRoute                                     2022                                    295166
Ipv6NoRoute
NatIn2out
QosPolicing
TailDrop
UnconfiguredIpv4Fia
UnconfiguredIpv6Fia
Wred
```

Observe data path packet drops using these two CLIs to associate them to interface and eventually to flow for a given reason of drop.

```
C8500# show platform hardware qfp active interface all statistics drop
-----
Drop Stats Summary:
note: 1) these drop stats are only updated when PAL
       reads the interface stats.
       2) the interface stats include the subinterface
```

```
Interface                                Rx Pkts                                Tx Pkts
-----
TenGigabitEthernet0/0/1                   0                                       1596360
TenGigabitEthernet0/0/2                   0                                       2
TenGigabitEthernet0/0/3                   0                                       23814997
TenGigabitEthernet0/1/0                   3453118                                0
```

```
C8500#
```

Data Plane: Software Object-Manager



```
C8500#show platform software object-manager fp active statistics
Forwarding Manager Asynchronous Object Manager Statistics
```

```
Object update: Pending-issue: 0, Pending-acknowledgement: 0
Batch begin:   Pending-issue: 0, Pending-acknowledgement: 0
Batch end:     Pending-issue: 0, Pending-acknowledgement: 0
Command:      Pending-acknowledgement: 0
Total-objects: 166
Stale-objects: 0
Resolve-objects: 0
Childless-delete-objects: 0
Error-objects: 0
Paused-types: 3
```

This CLI helps to confirm there are no programming issues from Control-plane (RP) to data plane (ESP). Pending-issue, Pending-acknowledgement count should always be 0.

```
C8500#
```

Control Plane Policing- CoPP

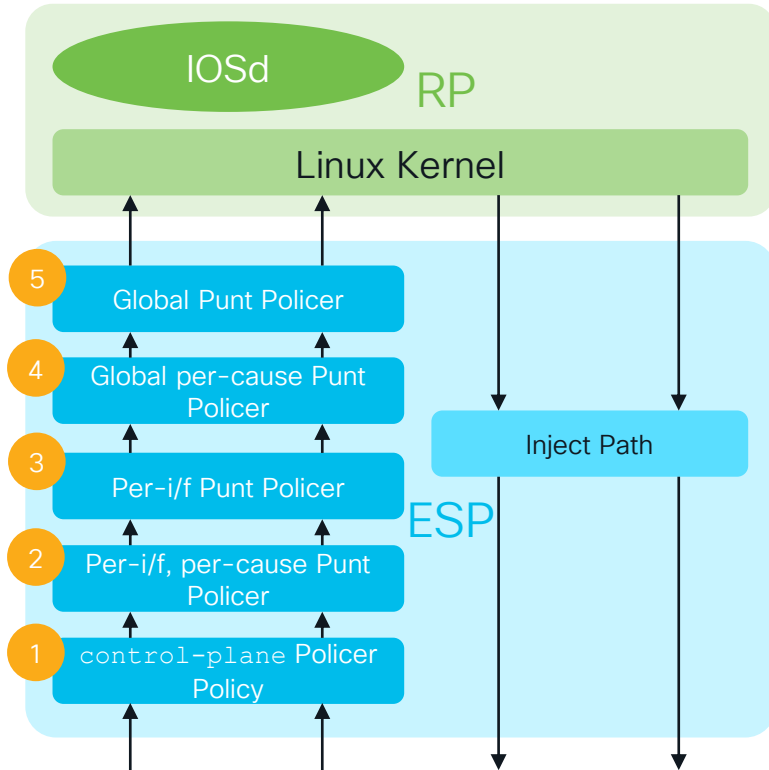

Classification Criteria for CoPP

- match access-group
- match dscp
- match ip dscp
- match ip precedence
- match precedence
- match protocol arp
- match protocol ipv6
- match protocol pppoe
- match protocol pppoe-discovery
- match qos-group
- match ipv6 acl hbh

Control-Plane CoPP Policer (rate based)



1

```
C8500# show policy-map control-plane  
Control Plane
```

```
Service-policy input: test
```

```
Class-map: p0 (match-all)
```

```
0 packets, 0 bytes  
5 minute offered rate 0000 bps, drop rate  
Match: precedence 0
```

```
police:
```

```
    cir 100000 bps, bc 3125 bytes  
    conformed 0 packets, 0 bytes; actions:  
    transmit  
    exceeded 0 packets, 0 bytes; actions:  
    drop  
    conformed 0000 bps, exceeded 0000 bps
```

```
Class-map: p1 (match-all)
```

```
0 packets, 0 bytes  
5 minute offered rate 0000 bps, drop rate  
Match: precedence 1
```

```
police:
```

```
    cir 100000 bps, bc 3125 bytes  
    conformed 0 packets, 0 bytes; actions:  
    transmit  
    exceeded 0 packets, 0 bytes; actions:  
    drop  
    conformed 0000 bps, exceeded 0000 bps
```

```
Class-map: class-default (match-any)
```

```
6 packets, 317 bytes  
5 minute offered rate 0000 bps, drop rate 0000 bps  
Match: any
```

```
police:
```

```
    cir 200000 bps, bc 6250 bytes  
    conformed 6 packets, 317 bytes; actions:  
    transmit  
    exceeded 0 packets, 0 bytes; actions:  
    drop  
    conformed 0000 bps, exceeded 0000 bps
```

Per-interface, per-cause drops

2 *Oct 11 10:13:09.582: %IOSXE-5-PLATFORM: R0/0: cpp_cp: QFP:0.0 Thread:000
 TS:00000086653236084292 %PUNT_INJECT-5-DROP_PUNT_INTF: punt interface
 policer drop packet from GigabitEthernet2/0/0, cause bfd-control (0x2d)

3 *Oct 11 10:13:05.411: %IOSXE-5-PLATFORM: R0/0: cpp_cp: QFP:0.0 Thread:000
 TS:00000086653236084292 %PUNT_INJECT-5-DROP_PUNT_INTF: punt interface policer
 drop packet from GigabitEthernet2/0/0

```
C8500# show platform hardware qfp active statistics drop
-----
Global Drop Stats                               Packets                               Octets
-----
PuntPerIntfPolicerDrops                        257                                   274166

C8500#
```

The statistic above is the total of per-interface and per-cause per-interface drops on the system.

Global per-cause Punt Policer



4

```
C8500# show platform software punt-policer
```

```
Per Punt-Cause Policer Configuration and Packet Counters
```

| Punt Cause | Description | Config Rate (pps) | | Conform Packets | | Dropped Packets | | Config Burst (pkts) | | Config Alert | |
|------------|------------------------------|-------------------|-------|-----------------|------|-----------------|------|---------------------|-------|--------------|------|
| | | Normal | High | Normal | High | Normal | High | Normal | High | Normal | High |
| 2 | IPv4 Options | 4000 | 3000 | 0 | 0 | 0 | 0 | 4000 | 3000 | Off | Off |
| 3 | Layer2 control and legacy | 40000 | 10000 | 0 | 0 | 0 | 0 | 40000 | 10000 | Off | Off |
| 4 | PPP Control | 2000 | 1000 | 0 | 0 | 0 | 0 | 2000 | 1000 | Off | Off |
| 5 | CLNS IS-IS Control | 40000 | 10000 | 0 | 0 | 0 | 0 | 40000 | 10000 | Off | Off |
| 6 | HDLC keepalives | 2000 | 1000 | 0 | 0 | 0 | 0 | 2000 | 1000 | Off | Off |
| 7 | ARP request or response | 2000 | 1000 | 0 | 0 | 0 | 0 | 2000 | 1000 | Off | Off |
| 8 | Reverse ARP request or repso | 2000 | 1000 | 0 | 0 | 0 | 0 | 2000 | 1000 | Off | Off |
| 9 | Frame-relay LMI Control | 2000 | 1000 | 0 | 0 | 0 | 0 | 2000 | 1000 | Off | Off |
| 10 | Incomplete adjacency | 2000 | 1000 | 0 | 0 | 0 | 0 | 2000 | 1000 | Off | Off |
| 11 | For-us data | 40000 | 5000 | 0 | 0 | 0 | 0 | 40000 | 5000 | Off | Off |
| 12 | Mcast Directly Connected Sou | 2000 | 1000 | 0 | 0 | 0 | 0 | 2000 | 1000 | Off | Off |
| 13 | Mcast IPv4 Options data pack | 2000 | 1000 | 0 | 0 | 0 | 0 | 2000 | 1000 | Off | Off |
| 15 | MPLS TTL expired | 5120 | 2000 | 0 | 0 | 0 | 0 | 5120 | 2000 | Off | Off |
| 16 | MPLS Reserved label (ie: 0-1 | 5120 | 2000 | 0 | 0 | 0 | 0 | 5120 | 2000 | Off | Off |
| 18 | IPV6 Hop-by-hop Options | 2000 | 1000 | 0 | 0 | 0 | 0 | 2000 | 1000 | Off | Off |
| 19 | Mcast Internal Copy | 2000 | 1000 | 0 | 0 | 0 | 0 | 2000 | 1000 | Off | Off |
| 23 | Mcast IGMP Unroutable | 2000 | 1000 | 0 | 0 | 0 | 0 | 2000 | 1000 | Off | Off |
| 24 | Glean adjacency | 2000 | 5000 | 0 | 0 | 0 | 0 | 2000 | 5000 | Off | Off |

<snip>

Global Punt Policer



```
C8500# show platform hardware qfp active infrastructure punt statistics type global-drop
Global Drop Statistics
```

5

Number of global drop counters = 22

| Counter ID | Drop Counter Name | Packets |
|------------|---|---------|
| 000 | INVALID_COUNTER_SELECTED | 0 |
| 001 | INIT_PUNT_INVALID_PUNT_MODE | 0 |
| 002 | INIT_PUNT_INVALID_PUNT_CAUSE | 0 |
| 003 | INIT_PUNT_INVALID_INJECT_CAUSE | 0 |
| 004 | INIT_PUNT_MISSING_FEATURE_HDR_CALLBACK | 0 |
| 005 | INIT_PUNT_EXT_PATH_VECTOR_REQUIRED | 0 |
| 006 | INIT_PUNT_EXT_PATH_VECTOR_NOT_SUPPORTED | 0 |
| 007 | INIT_INJ_INVALID_INJECT_CAUSE | 0 |
| 008 | INIT_INJ_MISSING_FEATURE_HDR_CALLBACK | 0 |
| 009 | PUNT_INVALID_PUNT_CAUSE | 0 |
| 010 | PUNT_INVALID_COMMON_HDR_VERSION | 0 |
| 011 | PUNT_INVALID_PLATFORM_HDR_VERSION | 0 |

<snip>

Sample CoPP Configuration



```
ip access-list extended Catch-All-IP
 10 permit tcp any any
 20 permit udp any any
 30 permit icmp any any
 40 permit ip any any
ip access-list extended Management
 remark NOC traffic for trusted management
ip access-list extended Undesirable
 10 remark deny Undesirable traffic
 10 permit icmp any any fragments
```

```
class-map match-all Catch-All-IP
 match access-group name Catch-All-IP
class-map match-all Management
 match access-group name Management
class-map match-all ARP
 match protocol arp
class-map match-all Undesirable
 match access-group name Undesirable
```

```
policy-map CONTROL-PLANE-POLICY
 class Management
  police rate 100 pps burst 100 packets
  conform-action transmit
  exceed-action drop
 class Undesirable
  police rate 1 pps burst 1 packets
  conform-action drop
  exceed-action drop
 class ARP
  police rate 1 pps burst 50 packets
  conform-action transmit
  exceed-action drop
 class Catch-All-IP
  police rate 1 pps burst 100 packets
  conform-action transmit
  exceed-action drop
 class class-default
  police rate 100 pps burst 100 packets
  conform-action transmit
  exceed-action transmit
```

```
control-plane
 service-policy input CONTROL-PLANE-POLICY
```

Punt Path drops, statistics



```
C8500# show platform hardware qfp active infrastructure punt statistics type queue-stats
Queue Statistics
```

| Interface Name | Queue ID | Pri | Queue Limit | Queue Depth | Enqueued Packets | Tail Drop Packets |
|------------------|----------|-----|-------------|-------------|------------------|-------------------|
| internal0/0/rp:0 | 0c90 | Lo | 6250002 | 0 | 80 | 0 |

```
C8500# show platform hardware qfp active infrastructure punt statistics type global-drop
Global Drop Statistics
```

```
Number of global drop counters = 22
```

| Counter ID | Drop Counter Name | |
|------------|--|---|
| 000 | INVALID_COUNTER_SELECTED | |
| 001 | INIT_PUNT_INVALID_PUNT_MODE | 0 |
| 002 | INIT_PUNT_INVALID_PUNT_CAUSE | 0 |
| 003 | INIT_PUNT_INVALID_INJECT_CAUSE | 0 |
| 004 | INIT_PUNT_MISSING_FEATURE_HDR_CALLBACK | 0 |
| 005 | INIT_PUNT_EXT_PATH_VECTOR_REQUIRED | 0 |

```
<snip>
```

These are very useful CLIs to associate control-plane packet drop in situation of excess control plane destined traffic, DoS attacks, etc. You will be able to understand what protocol traffic is flooding the control plane/punt path.

Embedded Packet Capture



```
C8500(config)#ip access-list extended test
C8500(config-ext-nacl)#permit ip any any
C8500(config-ext-nacl)#end
C8500#
C8500#monitor capture my_capture access-list test
C8500#monitor capture my_capture limit duration 10
C8500#monitor capture my_capture interface Te0/0/0 both
C8500#monitor capture my_capture buffer circular size 10
C8500#monitor capture my_capture start
Started capture point : my_capture
C8500#
*Feb 15 03:00:39.747: %BUFCAP-6-ENABLE: Capture Point my_capture enabled.
C8500#
C8500#monitor capture my_capture export bootflash:test.pcap
Exported Successfully
```

- Captures received or sent packets
- Shows what packets look like
- Hex dump analysis or export to decoder (sniffer)
- Does not tell us what happened to the packet

```
C8500#monitor capture my_capture stop
Stopped capture point : my_capture
C8500#
```

```
C8500# show monitor capture mycap buffer dump
0
0000: 01005E00 00020000 0C07AC1D 080045C0  ..^.....E.
0010: 00300000 00000111 CFDC091D 0002E000  .0.....
0020: 000207C1 07C1001C 802A0000 10030AFA  .....*.....
0030: 1D006369 73636F00 0000091D 0001      ..example.....
<snip>
```

References





Catalyst 8500 References

- Datasheet:
<https://www.cisco.com/c/en/us/products/collateral/routers/catalyst-8500-series-edge-platforms/datasheet-c78-744089.html>
- Frequently Asked Questions:
<https://www.cisco.com/c/en/us/products/collateral/routers/catalyst-8500-series-edge-platforms/q-and-a-c67-744086.html>
- Ordering Guide:
<https://www.cisco.com/c/en/us/products/collateral/routers/catalyst-8500-series-edge-platforms/guide-c07-744092.html>
- Architecture Whitepaper:
<https://www.cisco.com/c/en/us/products/collateral/routers/catalyst-8500-series-edge-platforms/white-paper-c11-2395855.html>

Key Takeaways



Cisco Catalyst 8500 Series Edge Platforms

Best Platforms for Cloud-scale Enterprise Networks



01 Powerful Data Plane

02 Highly Scalable Control Plane

03 High Speed Multi-Cloud Access

04 Accelerated SD-WAN Services

“C8500 Platforms offer best in class hardware with rich software features for high performance use-cases!”



Powerful Data Plane
QFP 3.0, x86 FBD*

Hardware Accelerated Services



High Speed DIA, DCA
100/40/10/1GE Ports



High Scale SD-WAN
IPsec Tunnels



*FBD: Flow Based Distribution

Fill Out Your Session Surveys



Participants who fill out a minimum of 4 session surveys and the overall event survey will get a unique Cisco Live t-shirt.

(from 11:30 on Thursday, while supplies last)



All surveys can be taken in the Cisco Events mobile app or by logging in to the Session Catalog and clicking the 'Participant Dashboard'



Content Catalog

Continue your education

- Visit the Cisco Showcase for related demos
- Book your one-on-one Meet the Engineer meeting
- Attend the interactive education with DevNet, Capture the Flag, and Walk-in Labs
- Visit the On-Demand Library for more sessions at ciscolive.com/on-demand. Sessions from this event will be available from March 3.



Thank you

CISCO *Live!*



CISCO *Live!*

GO BEYOND

A series of overlapping, vertically-oriented ovals in various shades of blue, ranging from light to dark, positioned on the right side of the image.